

6110(5010) Gear Cab TYPE WIRING DIAGRAM (A3)

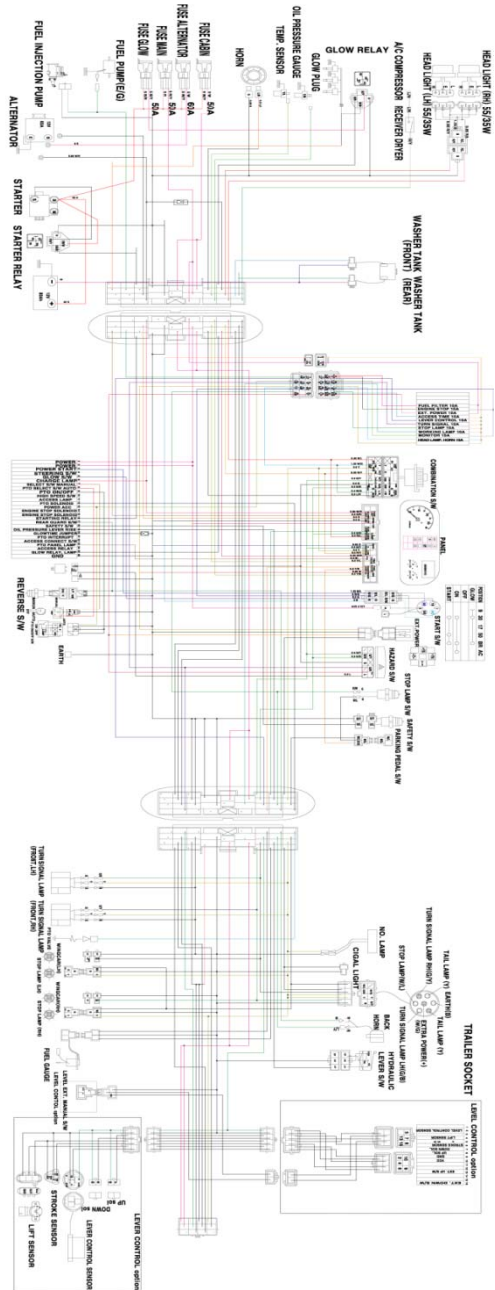

6110(5010)Gear Cab ELECTRIC SYSTEM DIAGRAM

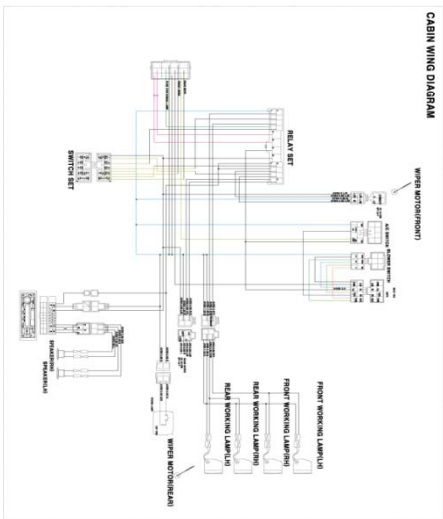
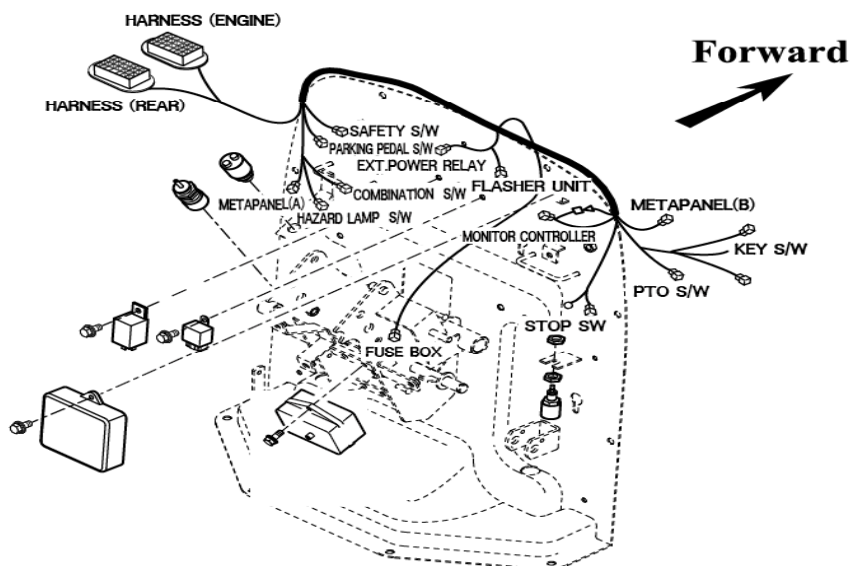

- Ⓐ GLOW FUSE
- Ⓑ CABIN FUSE
- Ⓒ MAIN FUSE
- Ⓓ CHARGING FUSE
- Ⓔ START RELAY
- Ⓕ PULL COIL RELAY
- Ⓖ GLOW RELAY

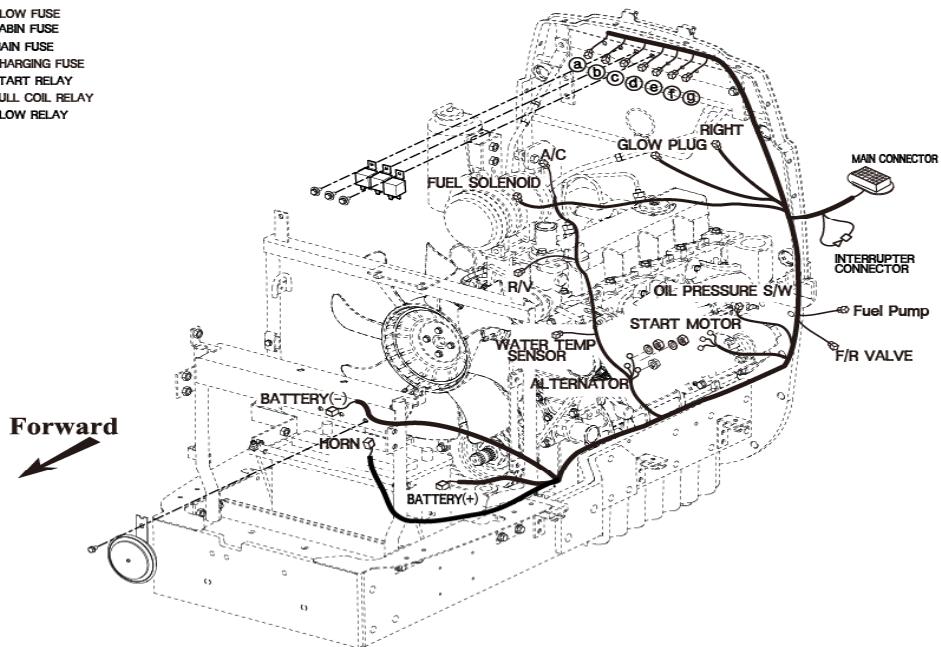

6110(5010) Gear Cab WIRING DIAGRAM (1)

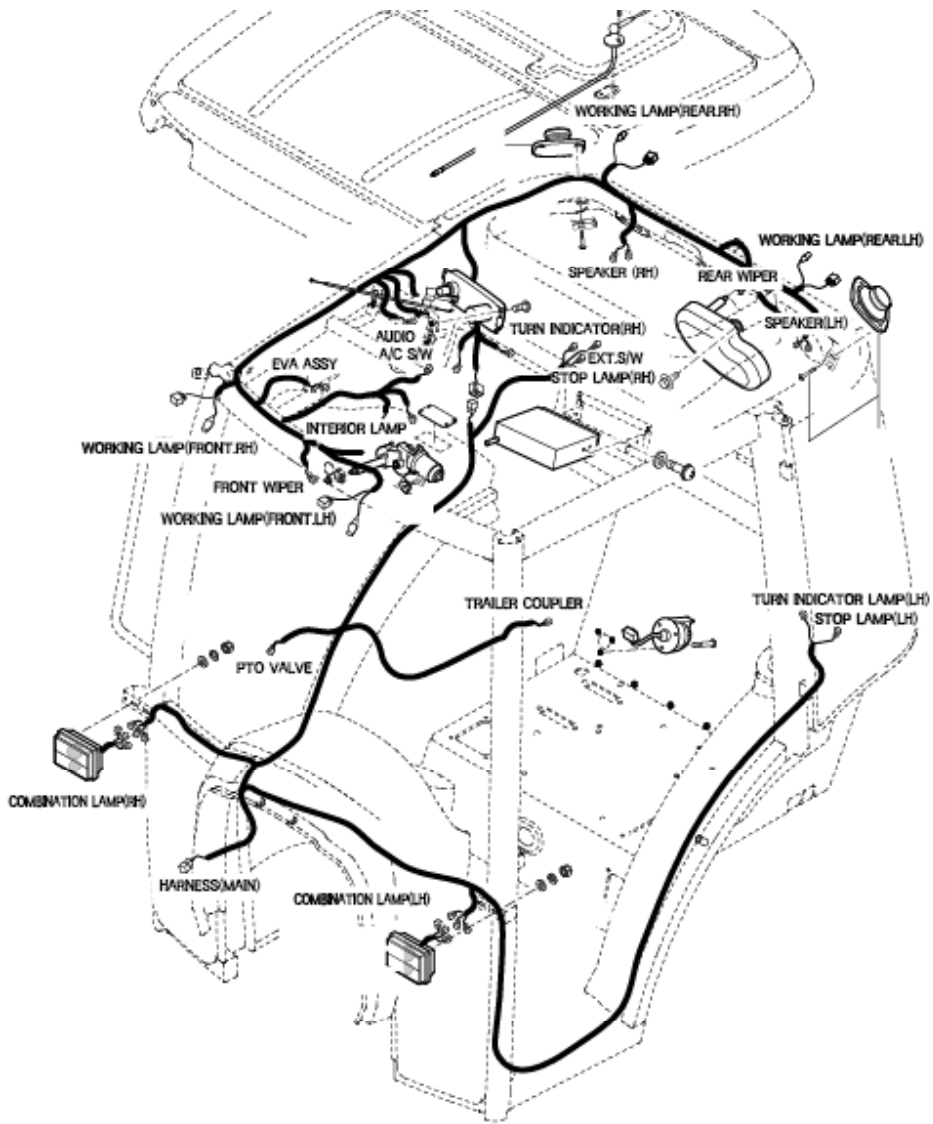

6110(5010) Gear CABIN WIRING DIAGRAM (2)

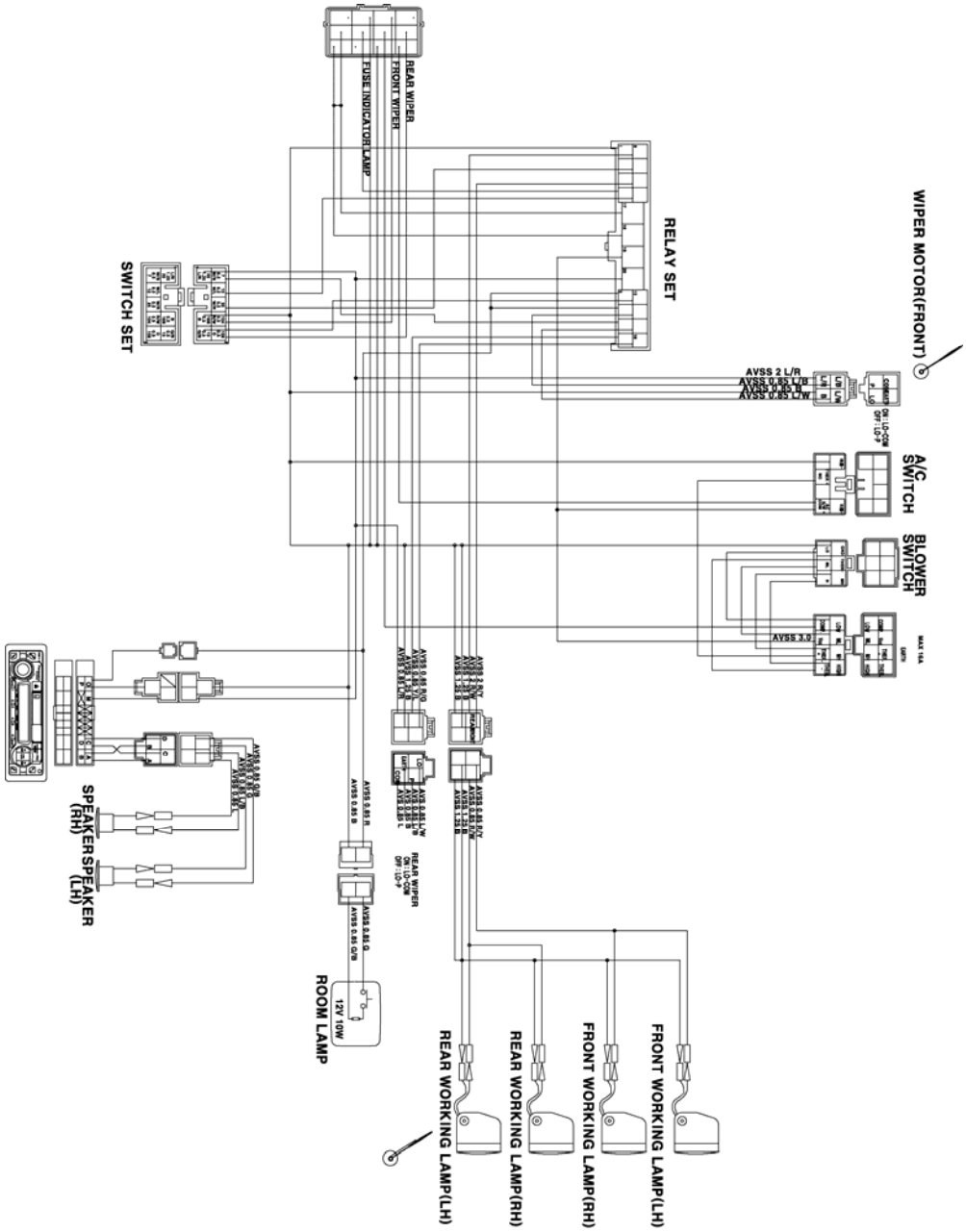

6110(5010) Gear CABIN WIRING DIAGRAM (3)

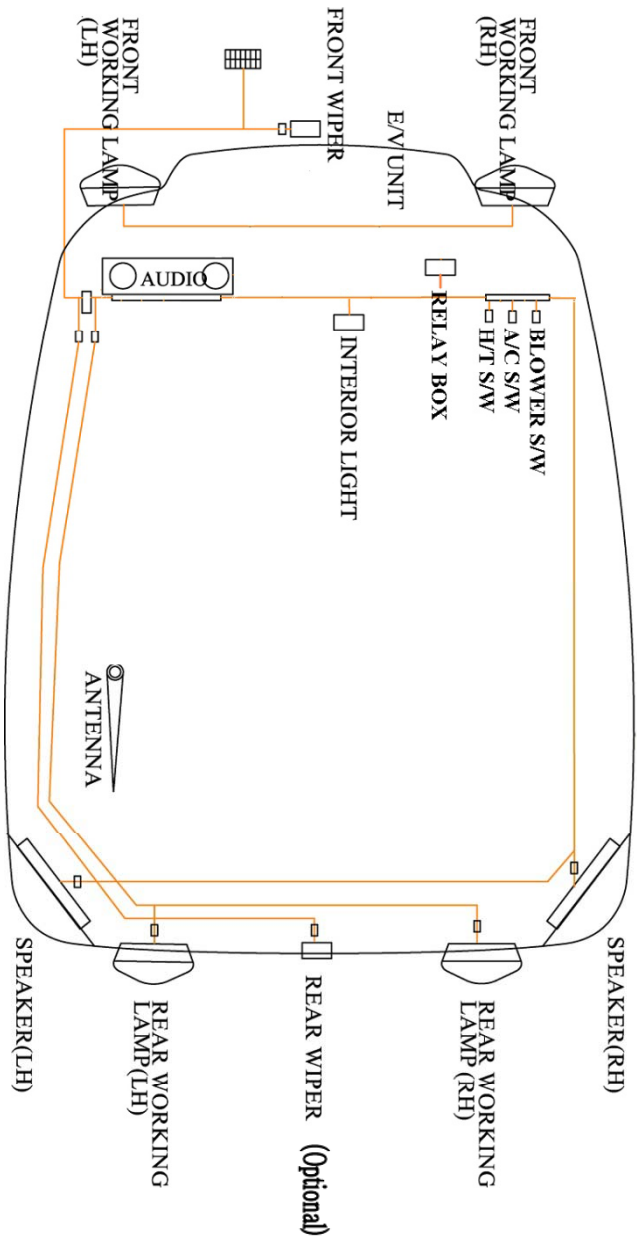

- ▶ Drawing for fixing position of the fuse
- ▶ Wiring diagram of the electric instrument

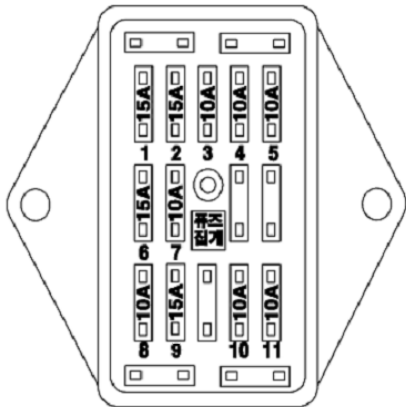

1. PANEL
2. LIGHT, HORN
3. WORKING LIGHT
4. STOP LAMP
5. TURN SIGNAL
6. CONTROLLER
7. ENGINE STOP
8. FUEL PUMP
9. COUPLER
10. AUTO ROLLING
11. QUICK TURN

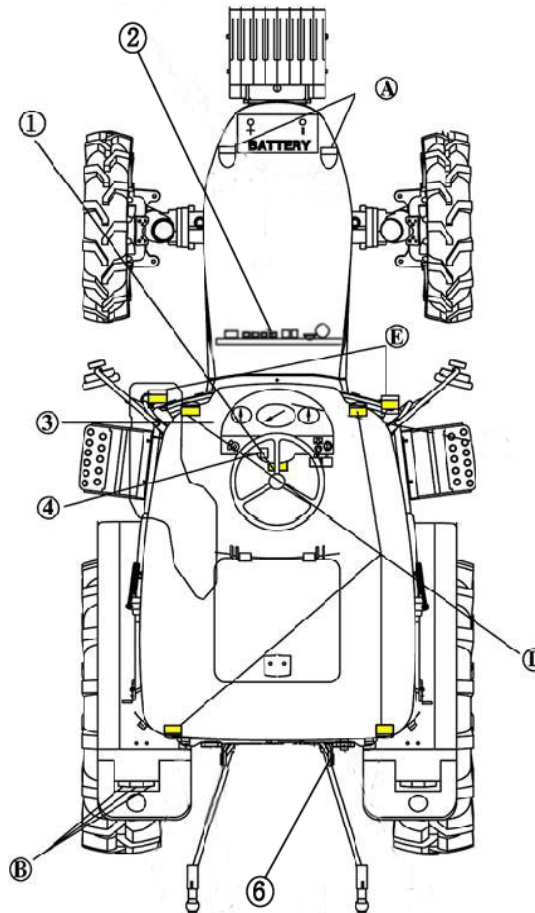

1	FUSE BOX
2	SLOW BLOW FUSE
3	UNITS FOR DIRECTION SIGNAL RELAY FOR THE POWER
4	PTO MONITOR
6	COUPLER FOR THE TRAILER

A	HEAD LAMP	12V55W
B	DIRECTION SIGNAL LAMP	12V21W
	STOP LAMP BACK LIGHT	21/5W
D	WORKING LAMP	12V35W
E	DIRECTION SIGNAL LAMP	12V21W
	SIDE LAMP	21V5W
G	NUMBER LAMP (EU)	12V10W

© 6110 Gear POWER TRAIN

