

MAHINDRA

T R A C T O R S

OPERATOR'S MANUAL & INSTALLATION INSTRUCTION 'ML114' Series

Click here to go on

[INDEX](#)

[Main Menu](#)



Cultivate
Your
DreamsSM

**Includes: Operator's Manual and Installation
Instructions**

Mahindra USA

Model ML114

Front End Loader



Rev. March 2005

1503-1059

WARRANTY CONDITIONS

Warranty Coverage:

Mahindra USA, Inc., herein referred to as Mahindra, undertakes to replace or repair any part of a Mahindra loader where damage has been proven to be caused by defects in material or workmanship.

This Warranty is valid for a period of 1 year for all hydraulic components and attachments and for a period of 2 years for all other loader components from the date of the original retail sale. Parts replaced or repaired under the terms of this Warranty are guaranteed only until the original warranty expires.

It is further understood and agreed that the defect should be immediately reported to the Selling Dealer. The Selling Dealer will generally perform Warranty repairs or replacements and the Purchaser shall deliver the Mahindra Loader to the Dealer's place of business for repair. In the event Purchaser is located more than 75 miles from the Selling Dealer, any Mahindra Dealer authorized to sell and service Mahindra Products may perform the repair at its dealership.

The obligation of Mahindra to the Purchaser under this Warranty is limited to the repair or replacement of defective parts by an authorized Mahindra dealer. Repair or replacement in accordance with this Warranty shall constitute fulfillment of all liabilities of Mahindra and the Selling Dealer in respect to Mahindra Loaders.

There are no warranties beyond those which expressly appear herein. Any implied warranty of merchantability or fitness for a particular purpose is specifically excluded here from.

Warranty Provisions:

Mahindra's liability under this Warranty is subject to the observance by the Purchaser of the following provisions:

- The purchaser shall at all times in the operation of any Mahindra Product, use those brands and grades of lubricating oils, lubricants or fuel and spare parts officially approved by Mahindra.
- The Mahindra Loaders shall have been used in accordance with the procedures specified in the Operator's Manual. This Warranty does not extend to damage resulting from misapplication, abuse, misuse, failure to perform maintenance, negligence, fire, accidents or changes or faulty mounting carried out by the Purchaser. When making a Warranty exchange of parts, the Purchaser shall compensate Mahindra for the time that the parts have been used if they have been exposed to extreme wear.
- Compensation is not paid for physical harm, deadlock, resulting damages, or other losses.
- To obtain warranty service, the Purchaser must (1) report the product defect to an authorized Mahindra dealer and request repair within the applicable warranty term and (2) present evidence of purchase or date of original use.
- The Warranty shall be void if the Mahindra Loader has been altered or repaired outside of a Mahindra dealership in a manner, which, in the sole judgment of Mahindra, affects its performance, stability, or reliability.
- The customer shall be responsible for transportation expenses for the Mahindra Loader to the dealership or travel of dealer personnel to customer location for Warranty repair. The customer shall also pay any premium for overtime labor requested by the customer.
- Temporary repairs or additional costs due to the work being performed after normal working hours will not be compensated.
- The above warranty is in lieu of all other warranties on Mahindra's behalf and neither party assumes any other liability in connection with Mahindra's Products.
- Any dispute arising between Mahindra and the Purchaser concerning the liability of Mahindra under this warranty shall be subject to the laws of the State of Texas.

Right To Make Design and Product Changes:

Mahindra reserves the right to make changes in the design and other changes in its Mahindra Products at any time without incurring any obligation with respect to any product previously ordered, sold or shipped.

CONGRATULATIONS

You are now the proud owner of a MAHINDRA ML114 Loader. This loader is a product of quality engineering and manufacturing. It is made of fine materials and under a rigid quality control system. It will give you long, satisfactory service. To obtain the best use of your loader, please read this manual carefully. It will help you become familiar with the operation of the loader and contains many helpful hints about loader maintenance. The immediate use of new techniques in the manufacture of products may cause some small parts of this manual to be outdated. Mahindra dealers will have the most up-to-date information. Please do not hesitate to consult with them.

SAFETY ALERTS

This symbol, the industry's "Safety Alert Symbol," is used throughout this manual and on labels to warn of the possibility of personal injury. When you see this symbol, carefully read the messages and be alert to the possibility of injury or death. It is essential you read these instructions and safety regulations before you attempt to assemble or use this unit.

**DANGER:**

Indicates an imminently hazardous situation which, if not avoided, will result in death or serious injury.

**WARNING:**

Indicates a potentially hazardous situation which, if not avoided, could result in death or serious injury.

**CAUTION:**

Indicates a potentially hazardous situation which, if not avoided, may result in minor or moderate injury.

IMPORTANT:

Indicates that equipment or property damage could result if instructions are not followed.

NOTE:

Gives helpful information.



SAFETY

Most tractor and/or loader equipment accidents can be avoided by following simple safety precautions. The safety information given in this manual does not replace safety codes, insurance requirements, federal, state, and local laws. Make sure your machine has the correct equipment required by your local laws and regulations. Understand that your safety and the safety of other persons are measured by how you service and operate this loader.

Know the position and operations of all controls before you try to operate. Make sure you check all controls in a safe area before starting.

Read this manual completely and thoroughly and make sure you understand all controls. All equipment has a limit. Make sure you are aware of the stability and load characteristics of this loader before you begin operation.



This safety alert symbol indicates important safety messages in this manual. When you see this symbol, carefully read the message that follows and be alert to the possibility of personal injury or death.



SAFETY PRECAUTIONS



READ MANUALS AND DECALS

1. Read and understand both the tractor and the loader Operator Manuals and all decals before using the loader.
2. Lack of knowledge can lead to accidents.
3. It is the loader owner's responsibility to make sure anyone operating the loader reads and understands this manual first before operating the machine.
4. Follow all safety, operating, and service instructions.
5. Replace damaged or illegible safety labels. See following pages for required labels.

ROPS AND SEAT BELT

6. Equip your tractor with an approved rollover-protective structure (ROPS) or ROPS Cab and seat belt for your protection.
7. ROPS (Roll-Over Protective Structures) and seat belt equipped tractors are recommended for operator use in all loader operations.
8. Operator should wear safety hard hat, safety glasses, safety shoes, and other PPE. Avoid wearing loose clothing or jewelry that may catch in moving parts.
9. Use seat belt as specified by tractor/ROPS manufacturer.

YOURSELF

10. Do not stand, walk, or work under a raised loader bucket or attachment unless it is securely blocked and held in position.
11. Operate controls only when properly seated in the operator's seat.
12. Only one person, the operator, should be on the machine when it is in operation.
13. Accidental movement of valve handle/handles or leak in the hydraulic system could cause the loader to drop, or attachment to dump, causing severe injury.

OTHERS

14. Do not allow anyone in loader work area, under raised loader, or to reach through the loader boom when the bucket or attachment is raised.
15. A frequent cause of personal injury or death is persons falling off and being run over. Inadvertent movement of the loader or attachment could result in serious injury or death.
16. Do not permit others to ride on your tractor, loader, bucket, or any attachment.
17. Do not lift or carry anyone on buckets, forks, probes, or any other portion of the loader or loader attachments.
18. Do not allow children or unqualified persons to operate equipment.



SAFETY PRECAUTIONS



PREPERATION

19. Move the wheels to the tractor manufacturer's widest recommended settings to increase stability.
20. For better stability, always use a tractor equipped with a wide front axle, never use a tractor equipped with a tricycle type front axle.
21. Add rear ballast or rear weight to the tractor to compensate for the load and increase stability.
22. Add recommended rear tire liquid weight or rear wheel weights for increased stability.
23. Do not modify, alter, or permit anyone else to modify or alter the loader, any of its components, or any loader function without first consulting a Mahindra dealer.
24. Assemble, remove, and reinstall the loader only as directed in this manual. Failure to do this could result in serious personal injury or death.
25. The loader may shift during shipping and handling, making it unstable on the pallet. Support loader with an overhead hoist or other suitable means prior to removing bands or attaching straps securing loader to pallet. Failure to do so could result in accidental tip-over of the loader that could cause serious injury to you and/or bystanders.

BEFORE OPERATION

26. Before starting the engine of your tractor, make sure all operating controls are in park lock or neutral position.
27. Be certain lights and safety markings, as provided by the tractor manufacturer, are clean and operating when transporting the tractor/loader on public roads. Be certain that the Slow Moving Vehicle (SMV) emblem is visible. Check with local law enforcement for specific requirements.

OPERATION

28. Add wheel ballast and/or rear weight to counterbalance tractor/loader for stability at maximum loader capacity.
29. Additional counterweight requirements will vary with loader attachments and equipment application.
30. Move and turn the tractor at low speeds.
31. Carry loader boom at a low position during normal operation.
32. Never travel at high speeds with bucket loaded.
33. Use caution when operating the loader with a raised bucket or attachment.
34. Avoid driving over loose fill, rocks, holes, or anything that may be dangerous for loader operation or movement.
35. Allow for the loader length when making turns.
36. Use caution when handling loose or unstable loads.
37. Gradually stop the loader boom when lowering or lifting loads.
38. When using remote hydraulic tractor valves on some tractors, the loader lift and dump cylinders will continue moving unless the valve handle/handles are manually returned to neutral, or until relief pressure is reached at the ends of piston strokes. Observe the bucket movement and maintain control with valve handle/handles.
39. Travel speed should be such that complete control and machine stability is maintained at all times. Where possible, avoid operating near ditches, embankments, and holes. Reduce speed when turning, crossing slopes, and on rough, slick or muddy surfaces.
40. A loader attachment should be transported in a low position at slow ground speeds. Make turns slowly and use the tractor brakes cautiously. A loaded attachment in the raised position alters the center of gravity location of the machine and increases the possibility of mishaps.
41. Be careful during loading, transporting, and stacking to minimize rolling bales and tractor tip over.
42. Do not use buckets, forks, or other attachments without bale retaining devices.
43. Operate the tractor and loader such that complete control and machine stability is maintained at all times.
44. When using a loader, be alert of bucket or attachment position at all times. Loader in raised position with bucket or attachment rolled back can dump material onto tractor causing damage or injury to tractor and/or operator.

LARGE HEAVY OBJECTS

45. Never use loader for handling large heavy objects, such as large round or rectangular bales, logs, and oil drums unless loader is equipped with attachment that is designed to handle such objects.
46. Handling large heavy objects can be extremely dangerous due to danger of rolling the tractor over.
47. Handling large heavy objects can be extremely dangerous due to danger of upending the tractor.
48. Handling large heavy objects can be extremely dangerous due to danger of the object rolling or sliding down the loader boom onto the operator.





SAFETY PRECAUTIONS



49. If you must handle large heavy objects, protect yourself by using caution, moving slowly, and avoiding bumps and rough ground.
50. If you must handle large heavy objects, protect yourself by never lifting load higher than necessary to clear the ground.
51. If you must handle large heavy objects, protect yourself by adding rear ballast to the tractor to compensate for weight of load.
52. If you must handle large heavy objects, protect yourself by never lifting large heavy objects that may roll or fall on the operator.
53. Never lift any load from any point of the loader with a chain, rope, or cable unless loader is equipped with a Factory approved attachment that was designed and built for this type of lifting. Always follow lifting instructions included with these attachments.
54. Use only Factory bale probe or bale retaining devise handler attachment when handling round bales.
55. Do not handle large square bales without a retaining device handler attachment.
56. Do not use buckets, forks, or other attachments without bale retaining devices.
57. Do not use loader for handling large, heavy objects such as logs, tanks, etc.

SLOPES

58. Stay off of slopes too steep for safe operation.
59. Shift down before you start up or down a hill with a heavy load. Avoid "free wheeling."
60. Use extreme caution when operating on a slope.
61. Always operate up and down the slope, never across the slope.

ELECTRICAL

62. Avoid contact with overhead wires, power lines, and obstacles when loader bucket or attachment is raised.
63. Electrocuting from power lines can occur with or without contact.
64. Check for underground utilities before digging below grade level.
65. Contact with overhead power lines can cause severe electrical burns or death from electrocution. Make sure there is enough clearance between raised equipment and overhead power lines.

HYDRAULIC

66. Do not tamper with the relief valve setting. This will void warranty and could cause damage to loader and/or tractor.
67. Escaping hydraulic fluid under pressure can have sufficient force to penetrate the skin, causing serious personal injury. Do not use HANDS to search for suspected leaks. If injured by escaping fluid, obtain medical treatment immediately.
68. Visually check for hydraulic leaks and broken, missing, or malfunctioning parts. Never use your hand to check for suspected leaks under pressure. Use a piece of cardboard or wood for this purpose. Escaping hydraulic fluid or diesel fuel leaking under pressure can have sufficient force to penetrate the skin and cause serious infection or other personal injury. If injured by leaking fluid, seek medical attention immediately.
69. To prevent personal injury, relieve all pressure before disconnecting fluid lines.
70. Before applying hydraulic pressure, make sure all hydraulic connections are tight and components are in good condition.
71. Be sure to purge all the air from the hydraulic system before attempting to raise or lower this machine.
72. When using remote hydraulic tractor valves on some tractors, the loader lift and dump cylinders will continue moving unless the valve handle/handles are manually returned to neutral, or until relief pressure is reached at the ends of piston strokes. Observe the bucket or attachment movement and maintain control with valve handle/handles.
73. Raised loader or boom can fall due to hydraulic system failure.
74. To avoid serious injury or death: Block up or securely support loader and boom before working underneath.
75. To avoid serious injury or death: Purge all air from hydraulic system before attempting to raise or lower loader or boom.
76. To avoid serious injury or death: Stand clear if lowering or raising loader or boom.
77. Do not use hand or skin to check for hydraulic leaks. Use cardboard or wood. Wear eye protection.
78. High pressure oil leaks can penetrate skin causing serious injury and gangrene. Consult a physician immediately.
79. Lower the loader or boom and release hydraulic pressure before loosening fittings.





SAFETY PRECAUTIONS



AFTER OPERATION

80. Before leaving the tractor seat, lower attachment or loader boom to ground, stop engine, lock parking brakes, put all controls in neutral, relieve hydraulic pressure, and remove key before leaving operator's seat.
81. Before disconnecting hydraulic lines, relieve all hydraulic pressure.
82. Make sure all parked loaders on stands are on a hard level surface with all safety devices engaged to prevent loader from falling and being damaged or injuring someone.
83. Always park loader with bucket attached to loader.
84. When a front loader is mounted on the tractor, enter and exit the operator's seat only from left side of the tractor.
85. Always park loader with a Factory attachment attached to the loader.
86. Special care should be taken to park or store attachments with points or sharp edges in a safe manner.
87. Make sure all parked loaders are on a hard level surface. Engage all safety devices to prevent loader from falling and being damaged or injuring someone. Do not repair loader if it is not mounted on the tractor. Loss of hydraulic fluid or removal of parts could cause loader to collapse resulting in injury.

REPAIR

88. Visually check for hydraulic leaks and broken, missing, or malfunctioning parts.
Make necessary repairs before operation.
89. To keep mounting kit hardware from loosening during loader operation, hardware must be torqued to specifications noted in operator manual.
90. Always wear safety goggles when servicing or repairing the machine.
91. When servicing or replacing pins in cylinder ends, bucket, etc., always use a brass drift and hammer. Failure to do so could result in injury from flying metal fragments.
92. Never tow from any point of the loader with a chain, rope, or cable. Doing so could cause a roll over or serious damage to the loader.





DANGER, WARNING, AND CAUTION DECAL SAFETY MESSAGES



0595-3000 WARNING DECAL

1. Add recommended rear wheel ballast and/or rear counter-weight for stability.
2. Move wheels to widest recommended setting to increase stability.
3. Move and turn tractor at low speeds.
4. In transport carry the load low.
5. Lower loader to the ground when parked.
6. Before servicing or adjusting equipment:
 - * lower loader to the ground.
 - * shut off engine.
7. Relieve hydraulic pressure before disconnecting oil lines.
8. Observe safety recommendations in Loader Operations Manual.

0595-3001 WARNING DECAL

Crushing Hazard

9. Stay away from under lift arms and bucket!
10. Do not stand or work under a raised loader.
11. Support bucket and lift arms before working under loader.
12. Lower loader to the ground before leaving seat.

0595-3002 DANGER DECAL

13. Keep machine clear of overhead power lines to avoid death or serious injury.

0595-3003 WARNING DECAL

14. To prevent rollback onto operator use special loader attachments for handling large objects such as stumps and large round bales.
15. Transport load as low as possible to avoid overturning.

0595-3004 WARNING DECAL

16. Read the operator's manual for complete operating instructions and safety information before operating the loader.
17. Be certain anyone operating the loader is aware of safe operating practices and potential hazards.
18. Operate the loader from the operator's seat only.
19. Do not lift or carry anyone on loader or work from bucket or attachment.
20. Do not walk or work under raised loader or bucket or attachment unless it is securely supported.
21. Avoid loose fill, rocks, and holes; they can be dangerous for loader operation or, movement.
22. Use extra caution when working on inclines.
23. Avoid overhead powerlines or obstacles when loader is raised.





DANGER, WARNING, AND CAUTION DECAL SAFETY MESSAGES



0595-2190 CAUTION DECAL

24. To prevent bodily injury and loader instability when detaching loader, equip loader with a material bucket.

0595-3050 DANGER DECAL

To avoid serious injury or death:

25. Unload only on a level surface.

26. Keep bystanders clear of work area when loading and unloading bales.

0595-3051 WARNING DECAL

27. Do not operate without confirmation that coupler pins are fully engaged.

28. Loader attachment can fall off if not properly attached.

To avoid serious injury or death:

29. Only use loader manufacturer approved attachments.

30. Read all operators manuals and decals before operating. Follow all safety operating and service instructions. Contact dealer for replacement parts.

0595-3052 WARNING DECAL

To avoid serious injury or death:

31. Do not use pallet fork attachment to lift large objects, round bales, or items that may roll or slide down loader arms onto the operator.

32. Never operate pallet fork without attaching plate guard.

33. Keep loads below pallet forks attaching plate guard heights.

34. Always transport loads with pallet forks low and level to ground.

35. Always keep pallet forks level when raising loads.

36. Avoid raising loads to full heights with pallet forks rolled back.

37. ROPS (Roll-Over Protective Structures) and seat belt equipped tractors are recommended for operator use in all pallet fork operations.

38. Do not lift or carry anyone on buckets, forks, probes, or any other portion of the loader or loader attachments.

39. Do not allow riders on tractor, loader, or forks.

40. Avoid contact with electrical power lines by loader or attachments.

0595-3053 WARNING DECAL

41. Maximum load limit on combined pair of forks is 5700 pounds.

0595-3054 CAUTION DECAL

To avoid serious injury or death:

42. Read operators manual and decals before operating.

43. Follow all safety operating, and service instructions. Contact dealer for replacement.

44. Be careful during loading transporting, and stacking to minimize rolling bales and tractor tip over. ROPS (Roll-Over Protective Structures) and seat belt equipped tractors are recommended for operator use in all bale probe operations.

45. Do not allow riders on tractor loader or bale probe.

46. Avoid loading/unloading bales on sloping or uneven surfaces.

47. Avoid transporting with bales raised high. Keep bales tilted back and low to the surface while moving.

48. Approach, penetrate, and transport bales at low speeds. Reduce speeds on curves, hills rough ground, or when turning.

49. Do not lift anything with bale probe except round bales.

50. Never raise round bale to full height with bale probe rolled back.

51. Park and store bale probe points pointed against bale, building, or other stable object.





SAFETY DECALS



WARNING

1. Add recommended rear wheel ballast and/or rear counterweight for stability.
2. Move wheels to widest recommended setting to increase stability.
3. Move and turn tractor at low speeds.
4. In transport carry the load low.
5. Lower loader to the ground when parked.
6. Before servicing or adjusting equipment;
 - * lower loader to the ground.
 - * shut off engine.
7. Relieve hydraulic pressure before disconnecting oil lines.
8. Observe safety recommendations in Loader Operations Manual.

0595-3000

WARNING

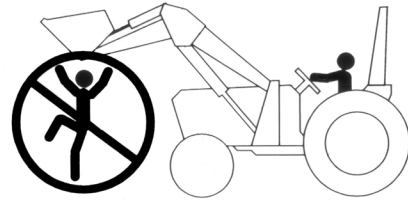

Crushing Hazard

Stay away from under lift arms and bucket!

1. Do not stand or work under a raised loader.
2. Support bucket and lift arms before working under loader.
3. Lower loader to the ground before leaving seat.

0595-3001

DANGER

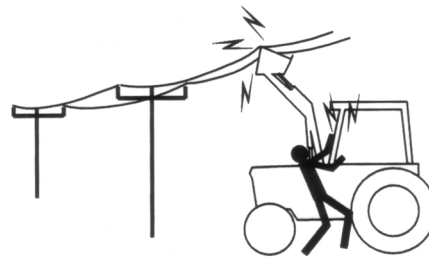

Keep machine clear of overhead power lines to avoid death or serious injury.

0595-3002



SAFETY DECALS



WARNING

To prevent rollback onto operator
- use special loader attachments
for handling large objects such as
stumps and large round bales.

Transport load as low as possible
to avoid overturning.

0595-3003

WARNING

1. Read the operator's manual for complete operating instructions and safety information before operating the loader.
2. Be certain anyone operating the loader is aware of safe operating practices and potential hazards.
3. Operate the loader from the operator's seat only.
4. Do not lift or carry anyone on loader or work from bucket or attachment.
5. Do not walk or work under raised loader or bucket or attachment unless it is securely supported.
6. Avoid loose fill, rocks and holes; they can be dangerous for loader operation or movement.
7. Use extra caution when working on inclines.
8. Avoid overhead powerlines or obstacles when loader is raised.

0595-3004

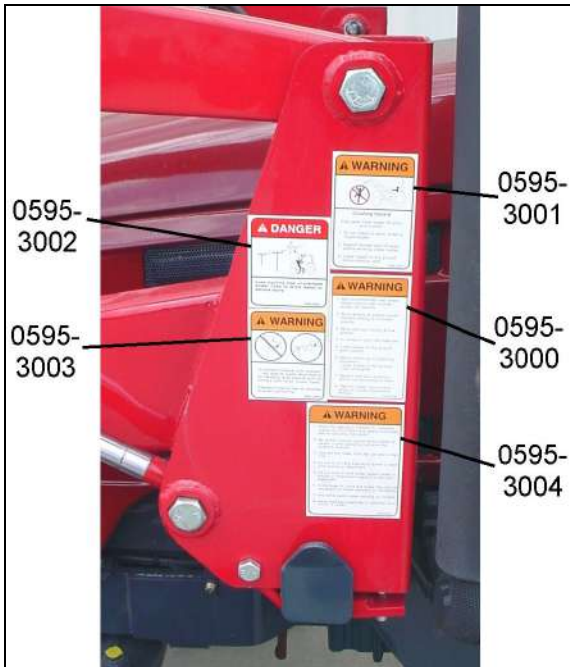

Safety Decal Locations

Important: Safety decals 0595-3000, 0595-3001, 0595-3002, 0595-3003, and 0595-3004 are located on the loader LH bearing box and are visible as you mount the tractor.

Care of Safety Decals

1. Keep safety decals clean and free of obstructing material.
2. Clean safety decals with soap and water and dry with a soft cloth.
3. Replace damaged or missing safety decals with new decals from your Mahindra Dealer.
4. If a component with a safety decal(s) affixed is replaced with a new part, make sure new safety decal(s) are attached in the same location(s) as the replaced components.
5. Mount new safety decals by applying on a clean dry surface and pressing air bubbles to outside edges.

TABLE OF CONTENTS

<p>1. Specifications 14 1.1. Attachment Specifications..... 14</p> <p>2. Introduction 15</p> <p>3. Installation Instructions 16 3.1. Tractor Preparation 16 3.2. Mounting Kit Installation..... 17 3.3. Hydraulic Installation..... 21 3.4. Loader Installation..... 26 3.5. Connect Hydraulics..... 26 3.6. Bucket Level Indicator..... 27</p> <p>4. Pre-Operation Instructions 28 4.1. Hydraulic Fluid 28 4.2. Initial Loader Operation..... 28 4.3. External Loader Valve 28 4.4. Loader Mounted Valve Equipped With Single Handle Control..... 28 4.5. Neutral Position..... 29 4.6. Float Position 29 4.7. Regenerative Dumping Position 29 4.8. Initial Loader Operation..... 29 4.9. Removing Air From Hydraulic System 29</p> <p>5. Daily Maintenance & Lubrication 30 5.1. Daily Checks 30 5.2. Loader Lubrication 30</p> <p>6. Operating Instructions 32 6.1. Filling The Bucket 32 6.2. Lifting The Load 32 6.3. Carrying The Load 32 6.4. Dumping The Bucket 33 6.5. Lowering The Bucket 33 6.6. Operating With Float Control 33 6.7. Loading From A Bank 33 6.8. Peeling And Scraping 34 6.9. Loading Low Trucks Or Spreaders From A Pile 34 6.10. Backfilling..... 34 6.11. Handling Large Heavy Objects 35 6.12. Back Grading 35</p> <p>7. Dismounting The Loader 36</p> <p>8. Mounting The Loader 39</p> <p>9. Optional Grill Guard 41 9.1. Installation Instructions 41</p> <p>10. Bucket– Pin On Or Skid Steer 42 10.1. Installation Instructions To Skid Steer Tool Carrier..... 42 10.2. Installation Instructions To Pin On Quick Attach..... 42 10.3. Installation Instructions Direct To Loader 42</p>	<p>11. Bale Probe – Pin On Or Skid Steer 43 11.1. Bale Probe 44 11.2. Assembly Instructions 44 11.3. Installation Instructions To Skid Steer Tool Carrier..... 44 11.4. Installation Instructions To Pin On Quick Attach 44 11.5. Installation Instructions Direct To Loader 44 11.6. Operating Instructions..... 44</p> <p>12. Pallet Fork – Pin On Or Skid Steer 45 12.1. Skid Steer Pallet Fork..... 45 12.2. Assembly Instructions..... 46 12.3. Installation Instructions To Skid Steer Tool Carrier..... 46 12.4. Installation Instructions To Pin On Quick Attach 46 12.5. Installation Instructions Direct To Loader 46 12.6. Operating Instructions..... 46 12.7. Loader Parking Instructions 46</p> <p>13. Optional Pin On Quick Attach System 47 13.1. Recommended Loader Factory Approved Attachments..... 47 13.2. Pin On Quick Attach 47</p> <p>14. Installing Bucket Or Attachment To Pin On Quick Attach..... 48 14.1. Recommended Loader Factory Approved Attachments..... 48 14.2. Keep These Areas Clean..... 48 14.3. Operating Instructions..... 48</p> <p>15. Removing Bucket Or Attachment From Pin On Quick Attach..... 50 15.1. Operating Instructions..... 50</p> <p>16. Optional Skid Steer Tool Carrier System 51 16.1. Recommended Loader Factory Approved Attachments..... 51 16.2. Non-Loader Factory Attachments..... 51 16.3. Skid Steer Tool Carrier System Service & Lubrication 52</p> <p>17. Installation & Operation Of Skid Steer Tool Carrier System 53 17.1. Installation Instructions 53 17.2. Skid Steer Tool Carrier Handles In Disengaged Position..... 53 17.3. Skid Steer Tool Carrier Handles In Engaged Position 53</p> <p>18. Installing Bucket Or Attachment To Skid Steer Tool Carrier..... 54 18.1. Operating Instructions..... 54</p>
---	---

19. Removing Bucket Or Attachment From Skid
Steer Tool Carrier.....57
19.1. Operating Instructions.....57

20. Trouble Shooting Procedures..... 58
21. Torque Chart..... 62

NOTES:



1. SPECIFICATIONS

**Model ML114
Front End Loader**

**For Use With
Model 4510
Tractor**

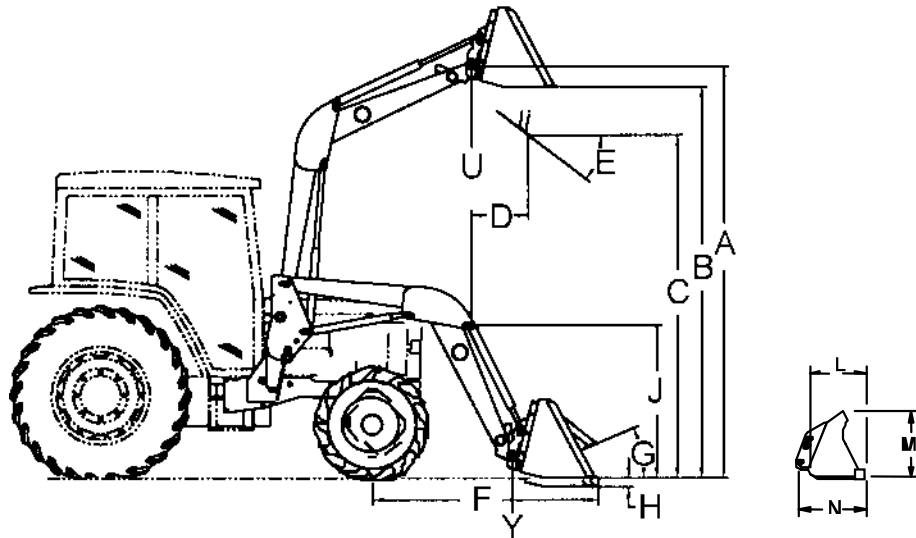

SPECIFICATIONS OF LOADER:	ML114
A. Maximum Lift Height to Pivot Pin	9' 3" (111")
B. Maximum Lift Height under Level Bucket	8' 9-1/8" (105-1/8")
C. Clearance with Bucket Fully Dumped	7' 5-3/4" (89-3/4")
D. Reach at Maximum Lift Height (to Grill)	2' 7-7/8" (31-7/8")
E. Maximum Dump Angle	58 degrees
F. Reach With Bucket on Ground	6' 3/4" (72-3/4")
G. Maximum Rollback Angle	19 degrees
H. Digging Depth	5.6"
J. Overall Height in Carry Position	4' 11-3/4" (59-3/4")
L. Bucket Depth	19.5"
M. Bucket Height	24.9"
N. Loader Bucket Pin to Front Cutting Edge	24.3"
U. Lift Capacity to Maximum Height at Pivot Pin	1,972 lb.
Y. Breakout Force at Ground Line at Pivot Pin	3,343 lb.

	1500 RPM	2000 RPM	2700(Full) RPM
Raising Time Ground Line to Maximum Lift Height	7.8 sec.	5.7 sec.	4.4 sec.
Lowering Time Maximum Lift Height to Ground Line	4.4 sec.	3.5 sec.	2.6 sec.
Dumping Time Full Rollback to Full Dump w/Regen	2.9 sec.	2.8 sec.	2.5 sec.
Rollback Time Full Dump to Full Rollback	3.9 sec.	2.9 sec.	2.6 sec.

Lift Cylinder Dia.	2"
Tilt Cylinder Dia.	2"
Relief Valve Setting (Loader Valve)	2300 psi

Specifications taken with Mounting Kit, Hose Kit, and 72" Pin On Standard Bucket.

Specifications based on ASAE standards S301.3 and furnished for general information only as they can vary with different tractor models. Specifications are subject to change without notice and without liability therefore.

1.1. ATTACHMENT SPECIFICATIONS

BUCKET	STRUCK CAPACITY	RATED SIZE CAPACITY
54" Pin On Material	9.20 cu. ft.	10.70 cu. ft.
60" Pin On Material	10.20 cu. ft.	11.90 cu. ft.
66" Pin On Material	11.30 cu. ft.	13.20 cu. ft.
72" Pin On Material	12.30 cu. ft.	14.50 cu. ft.
78" Pin On Material	13.40 cu. ft.	15.80 cu. ft.

2. INTRODUCTION

This manual provides safety, installation, operation, maintenance, removing, storing, and reinstalling instructions for your new mid-mount loader.

Your loader has been designed to give many years of satisfactory service. Successful operation and long life of the loader depends, of course, on proper operation and care. Please read this manual carefully and follow the instructions. Correct operation and maintenance will save much time and expense.

OBSERVE and follow all CAUTION, WARNING, and DANGER instructions to help prevent personal injury and damage to the loader. The reference to right hand (RH) and left hand (LH) used in this manual refers to the position when standing at the rear of the unit and facing forward.

If, at any time, you have a service problem with your loader or need new parts, contact your local Mahindra dealer. Your dealer will need the loader model number and serial number to give you prompt, efficient service. The serial number plate is located on the LH inside front area of boom.

KMW
Kansas Machine Works

KMW Ltd
P.O. Box 327
Sterling, KS 67579

Model No.

Serial No.



Before operating loader, check that your Dealer has covered the following information with you:

- Equipment has been completely assembled as directed.
- Equipment has been functionally tested for proper operation.
- Purchaser has been instructed in proper & safe operating methods:
 - Operators Safety Precautions
 - Tractor Wheel Tread-Tire & Inflation Recommendations
 - Tractor Hydraulic System & Loader Controls
 - Rear Ballast Recommendations
 - Hydraulic System Oil Level
 - Proper Loader Operation
 - Loader Removal
 - Loader Installation
 - Lubrication - Service Care
 - Storage
- Warranty Coverage & Operators Manual explained to purchaser.

Mahindra ML114 Loader Serial Number Information

LOADER SERIAL NUMBER _____

DATE PURCHASED _____

DEALER NAME _____

AND TELEPHONE NUMBER _____

3. INSTALLATION INSTRUCTIONS



CAUTION: Equip your tractor with a ROPS cab or frame for your protection. See your tractor/ROPS Operator Manual for correct seat belt usage.

Read entire instructions before beginning to install the loader. Personal injury and machine damage may be prevented if you read and understand these instructions and special safety messages.

When you are in the tractor seat looking forward, the RH and LH sides of the tractor and loader are the same as your right hand and left hand.

3.1. TRACTOR PREPARATION

3.1.1. Tractor Front Tires

Use front tires of equal size and maintain equal pressure in each tire. The pressure of the front tractor tires must be increased to the maximum approved pressure recommended by the tire manufacturer to compensate for additional load placed on the tires with the Front End Loader. See your tractor Operator Manual. Adjust the front tires to the widest recommended setting on adjustable models for maximum stability. Front end weights must NOT be used while loader is on the tractor.

3.1.2. Tractor Rear Tires

Maintain equal pressure in each of the rear tires. Use the widest recommended rear wheel setting for maximum stability.

3.1.3. Tractor Ballast



CAUTION: To help prevent rollover, use recommended rear tractor ballast and widest wheel settings to maximize stability. See your tractor Operator Manual for recommendations

Front tractor weights must only be used when the loader is parked. Weights must be removed before remounting loader or serious damage will occur to loader or tractor front axle due to excessive weight.

The use of adequate rear counterweight to counterbalance for maximum loader capacity is required for safe loader operation. Weight added to the rear of the tractor provides better traction and easier, more efficient loader operation.

IMPORTANT: Do not exceed the maximum load capacity of the tires on your tractor. See Tire and Wheel Specifications in tractor Operator Manual for more information.

3.1.4. Remove all loader components from shipping packaging.



WARNING: To avoid serious injury or death: Read before cutting bands or removing attaching straps. The loader may shift during shipping and handling, making it unstable on the pallet. Support loader with an overhead hoist or other suitable means prior to removing bands or attaching straps securing loader to pallet. Failure to do so could result in accidental tip-over of the loader that could cause serious injury to you and/or bystanders.



CAUTION: Lift and support all loader components safely.

3.2. MOUNTING KIT INSTALLATION

3.2.1. Position the loader on a hard level surface. The more level the surface the easier the loader is to install.

3.2.2. Remove lower horizontal exhaust covers from LH side of tractor.

3.2.3. Remove 3 engine frame bolts from each side of tractor. Save hardware.

3.2.4. Remove step from RH side of tractor. Save step and hardware.

3.2.5. Disconnect pressure, power beyond, and return hoses from hydraulic hose mount. Remove hydraulic hose mount from RH side of tractor. Save mount and hardware.



IMPORTANT: Do not tighten any hardware until all components are attached onto the tractor.



CAUTION: Lift and support all loader components safely.

Installation With Optional Grill Guard:

3.2.6. Tighten weight bracket bottom bolt securely.

NOTE: Tightening bottom bolt before removing front bolts will insure mounting holes remain aligned.

3.2.7. Remove front two bolts from weight bracket.

3.2.8. Locate front mount and optional grill guard over weight bracket. Install 14mm x 50mm hardware in these holes.

3.2.9. Position front mount spacer between rear of front mount and tractor frame. Install 5/8" x 2-1/2" hardware.

Optional Grill Guard

Front Mount

Front Mount Spacer

5/8"-11NC x 2-1/2"
Grade 5 Hex Bolt, 5/8"
Lockwasher, and Hex
Nut, 1 place each side

14mm x 2.0P x 50mm
Grade 8.8 Hex Bolt
and 9/16" Lockwasher,
2 places each side.

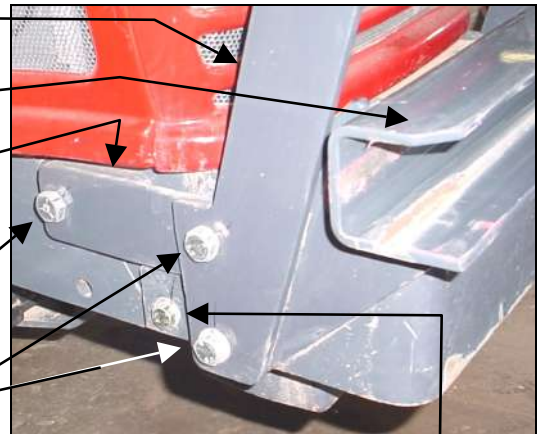

1st – Tighten Bottom Bolt Securely.

Installation Without Optional Grill Guard:

3.2.10. Tighten weight bracket bottom bolt securely.

NOTE: Tightening bottom bolt before removing front bolts will insure mounting holes remain aligned.

3.2.11. Remove front two bolts from weight bracket.

3.2.12. Locate front mount over weight bracket. Install 14mm x 40mm hardware in these holes.

3.2.13. Position front mount spacer between rear of front mount and tractor frame. Install 5/8" x 2-1/2" hardware.

Grill Guard shown is not used.

Front Mount

Front Mount Spacer

5/8"-11NC x 2-1/2"
Grade 5 Hex Bolt, 5/8"
Lockwasher, and Hex
Nut, 1 place each side

14mm x 2.0P x 40mm
Grade 8.8 Hex Bolt
and 9/16" Lockwasher,
2 places each side.

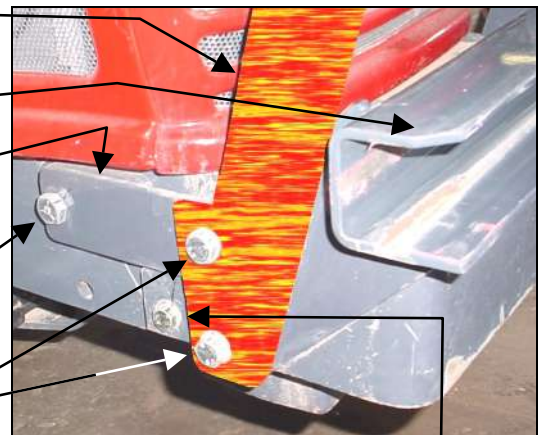

1st – Tighten Bottom Bolt Securely.

NOTE: Optional Grill Guard is shown fuzged out.

3.2.14. Remove front two bolts from RH & LH Tractor 3-point bracket. Save hardware.

3.2.15. Install RH & LH rear rail brackets to 3-point bracket using 12mm x 1.75P x 200mm Grade 8.8 Hex Bolt and Hex Nut, 2 places.

Mounting Kit 12mm x 1.75P x 200mm Grade 8.8 Hex Bolt and Tractor Lockwasher and Hex Nut, 2 places.

Rear Rail Bracket
3-Point Bracket

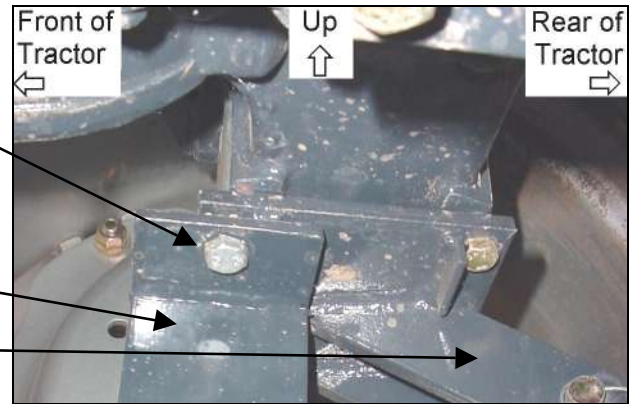

3.2.16. Install cross member to tractor engine frame. Secure using mounting kit 12mm x 45mm bolt and lockwasher just removed.

12mm x 1.25P x 45mm Grade 10.9 Hex Bolt from Mounting Kit and Tractor Lockwasher, 3 places each side.

Cross Member
Rear Rail

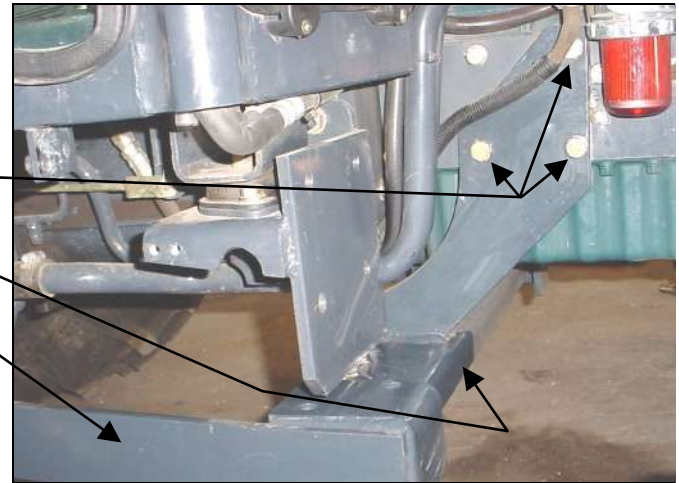

3.2.17. Lay rear rail on top of cross member on each side of tractor.

NOTE: Do not secure at this time.

3.2.18. Install RH & LH rear rails to RH & LH rear rail brackets previously installed. Secure using 1/2" x 1-1/2" hardware.

Rear Rail Bracket
Rear Rail

1/2"-13NC x 1-1/2" Grade 5 Hex Bolt, Lockwasher, Flatwasher, and Hex Nut, 2 places each side.

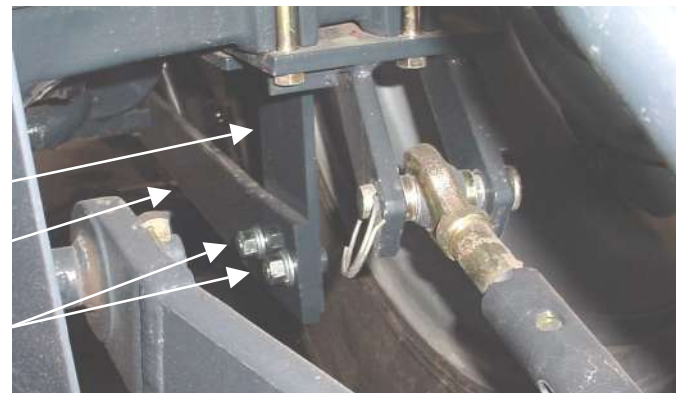

3.2.19. Reroute heater hoses underneath the cab through the channel provided by the TYM.

Heater hoses rerouted



3.2.20. Locate RH center bracket on top of rear rail and cross member. Secure to tractor using 16mm x 30mm hardware.

MARLENE - ? Lock

RH Center Bracket

16mm x 2.0P x 30mm Grade 8.8 Hex Bolt and Lockwasher, 4 places each side.

RH Rear Rail

Cross Member

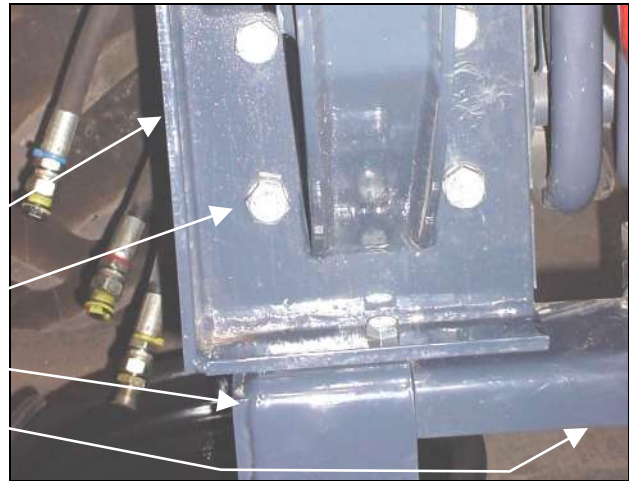

3.2.21. Locate LH center bracket on top of rear rail and cross member. Secure using 16mm x 30mm hardware.

LH Center Bracket

16mm x 2.0P x 30mm Grade 8.8 Hex Bolt and Lockwasher, 2 places each side.

Cross Member

LH Rear Rail

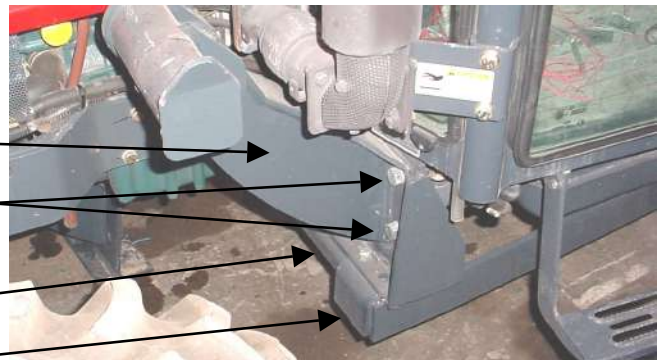

3.2.22. Align center bracket, rear rail, and cross member. Secure front side of components using 1/2" x 1-3/4" hardware.

Center Bracket

1/2"-13NC x 1-3/4" Grade 5 Hex Bolts, Lockwashers, and Hex Nuts, 1 place each side.

Rear Rail

Cross Member

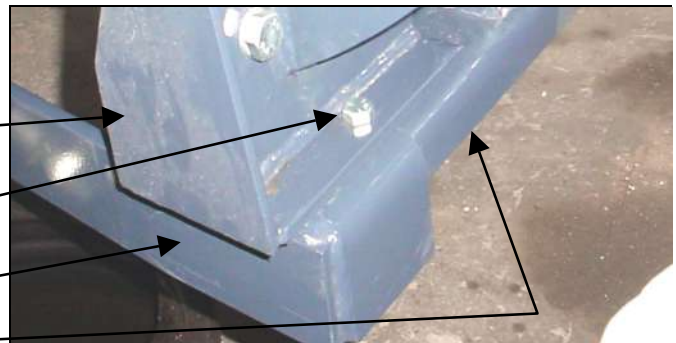

3.2.23. Secure rear side of components using 1/2" x 1-3/4" hardware.

Center Bracket

1/2"-13NC x 1-3/4" Grade 5 Hex Bolts, Lockwashers, and Hex Nuts, 2 places each side.

Cross Member

Rear Rail

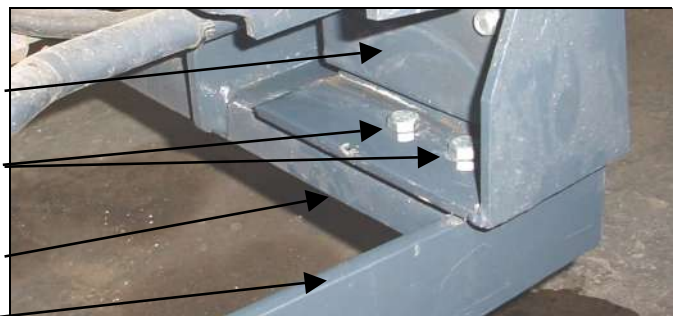

3.2.24. Rear view of rear rails mounted to cross members and rear rail brackets.

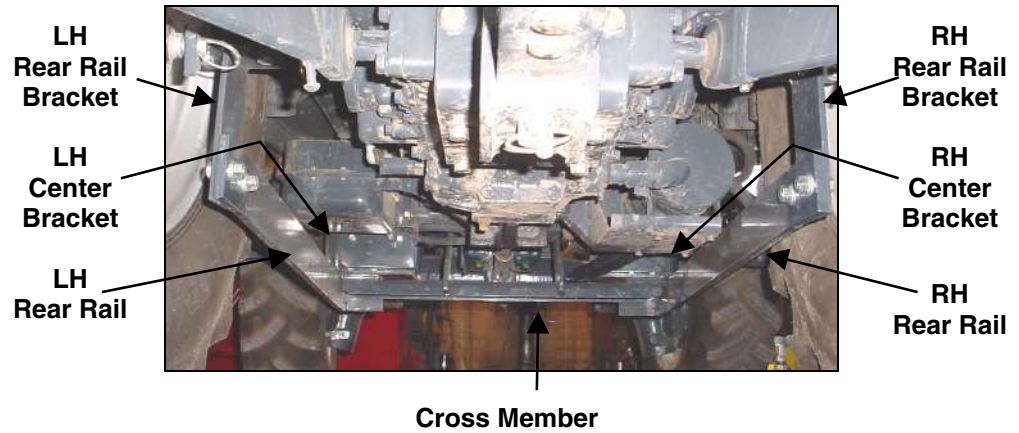

3.2.25. Verify that all mounting kit hardware has been torqued as specified before installing loader.

A. Identify hardware size and grade.

B. Refer to Torque Chart, page 62 and find correct torque for your hardware size and grade.

C. Torque hardware to this specification unless otherwise specified.

IMPORTANT NOTE: To keep mounting kit hardware from loosening during loader operation, hardware must be torqued to specifications.

3.3. HYDRAULIC INSTALLATION

3.3.1. Install 3/4" o-ring onto short end of bulkhead fitting, 4 places.

3.3.2. Install female quick coupler to o-ring/short end of bulkhead fitting, 4 places.

NOTE: O-ring must be located on correct side of bulkhead fitting or hydraulic oil leakage will occur.

3.3.3. Install 4 o-ring/bulkhead fittings with female quick couplers to mounting plate on RH center mounting bracket. Secure using Bulkhead Nut on bottom side of mounting place.

O-ring/Bulkhead Fitting, 4 places.

Mounting Plate located on RH Center Bracket

Bulkhead Nut, 4 places.

NOTE: O-ring must be located on top side.

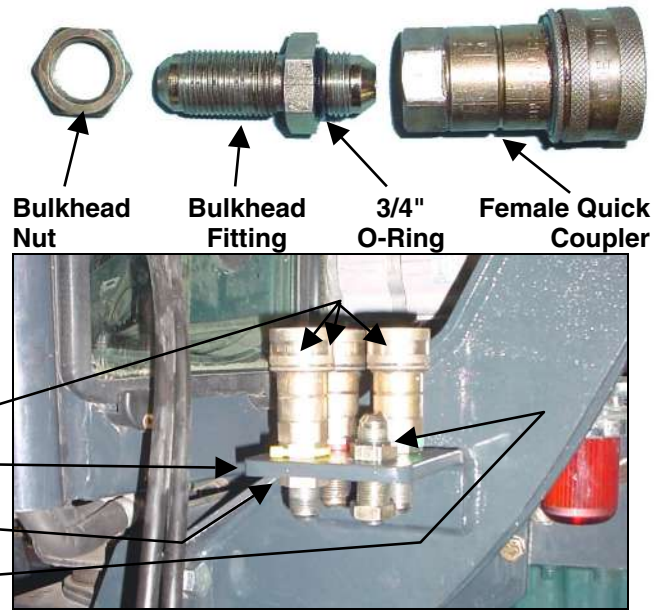

3.3.4. **Valve Assembly:** Install o-rings to (4) & (5) straight fittings.

NOTE: O-rings must be located on fittings as shown to prevent hydraulic oil from leaking.

3.3.5. Install fittings to valve as follows:

(1) **Power Beyond "PB" Port:** Install Fitting 90° JICF 3/4" x ORBM 3/4".

(2) **Return "OUT" Port:** Install 3/4" O-Ring to JICM 3/4" end of Straight Fitting.

(4) **Return "OUT" Port:** Install Fitting Straight JICM 3/4" x BSPP 1/2".

(3) **Pressure "IN" Port:** Install 3/4" O-Ring to JICM 3/4" end of Straight Fitting.

(5) **Pressure "IN" Port:** Install Fitting Straight JICM 3/4" x BSPP 1/2".

(6) **Port "A", "B", "C", & "D":** Install Fitting Straight JICM 9/16" x ORBM 9/16", 4 places.

(7) **Port "A", "B", "C", & "D":** Install Fitting 90° JICM 9/16" x JICF 9/16", 4 places. Orientate 90° Fittings as shown, then tighten.

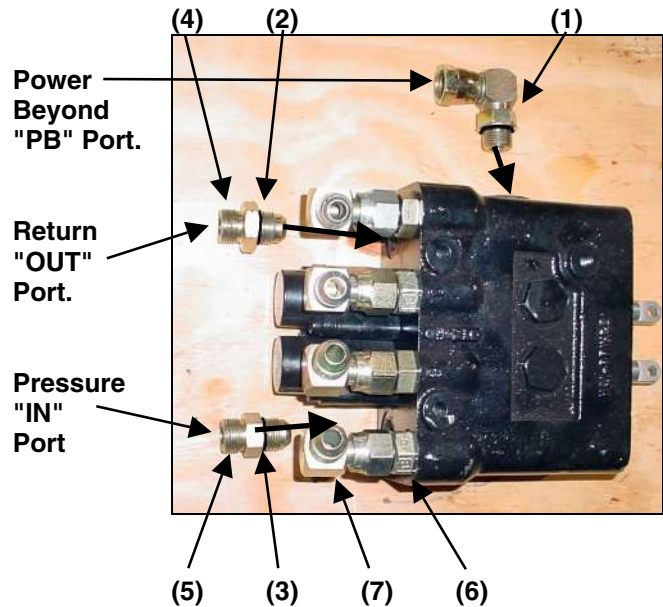

3.3.6. Install 40" hoses to working port fittings.
Ports "A", "B", "C", & "D": Install Hose 1/2" x 40" JICFS 9/16" x JICFS 3/4".

3.3.7. Using color nylon ties, install one on each working port hose. These color ties will allow easy identification of loader circuits when mounting and dismantling loader.

Port "D" Lift Cylinder Rod End Blue Tie

Port "C" Lift Cylinder Base End Green Tie

Port "B" Tilt Cylinder Rod End Red Tie

Port "A" Tilt Cylinder Base End Yellow Tie

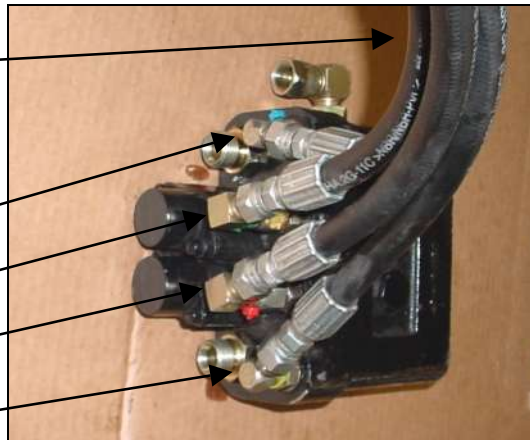

3.3.8. Install valve mount bracket to RH tractor steps using tractor step hardware.

Tractor Step Hardware
Valve Mount
RH Tractor Step



3.3.9. Secure valve to valve bracket using hardware shown.

Pressure "IN" Line
5/16"-18NC x 3/4" Grade 5 Hex Bolt and Lockwasher, 2 places.
Return "OUT" Line
Power Beyond "PB" Port (downwards)

Tilt Spool of Valve
Lift Spool of Valve

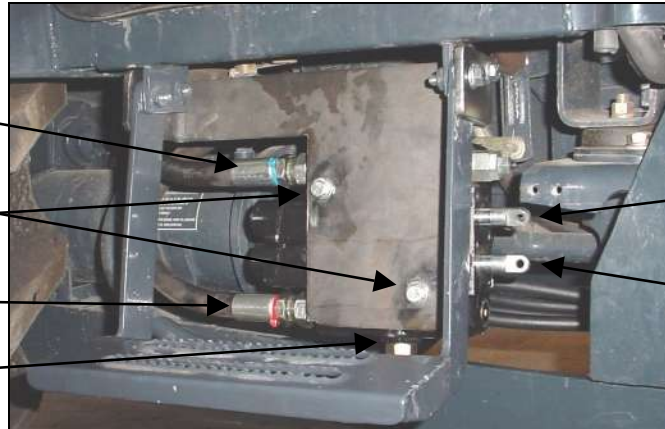

3.3.10. Attach pressure, power beyond, and return hoses to loader valve as shown.

3.3.11. Remove all twists from hoses then tighten hydraulic connections.

Tractor Pressure "IN" Hose
Tractor Return "OUT" Hose
Tractor Power Beyond "PB" Hose

Pressure "IN" Port of Valve
Return "OUT" Port of Valve
Power Beyond "PB" Port of Valve

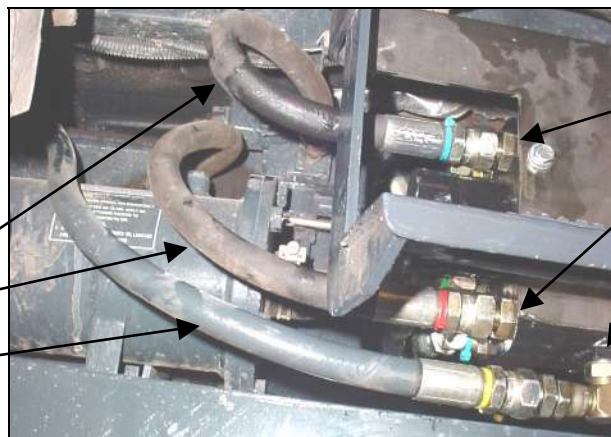

NOTE: Make sure the correct hose is connected to the correct port of valve.

3.3.12. Roll RH corner of cab rubber mat back to expose 4 mounting holes.

3.3.13. Attach controller bracket base to cab floor using hardware shown.

Controller Bracket
8mm x 1.25P x 20mm Grade 8.8 Hex Bolt and 5/16" Lockwasher, 4 places.
Controller Bracket Base

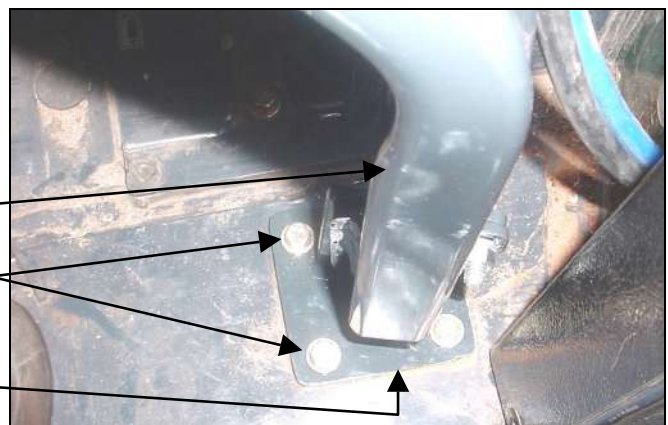

3.3.14. Install controller bracket to controller bracket base using hardware shown.

- Controller Bracket**
- 3/8"-16NC x 1-1/4" Grade 5 Hex Bolt, Lockwasher, and Nut (no Flatwasher).**
- 3/8"-16NC x 1-1/4" Grade 5 Hex Bolt, Lockwasher, Flatwasher, and Nut.**
- Controller Bracket Base**

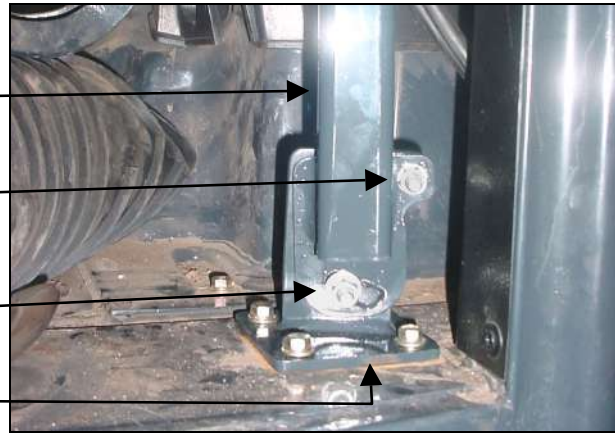

3.3.15. Cut RH cab rubber mat to fit around controller bracket. Reposition cab rubber mat on floor.

3.3.16. Install single handle controller to mounting bracket using hardware shown.

NOTE: King pin of handle must be located in position shown or loader will not function correctly.

5/16"-18NC x 4" Grade 5 Hex Bolt, Flatwasher, Lockwasher, and Hex Nut, 1 places.

- Single Handle Controller King Pin**
- Single Handle Controller**
- Controller Bracket**

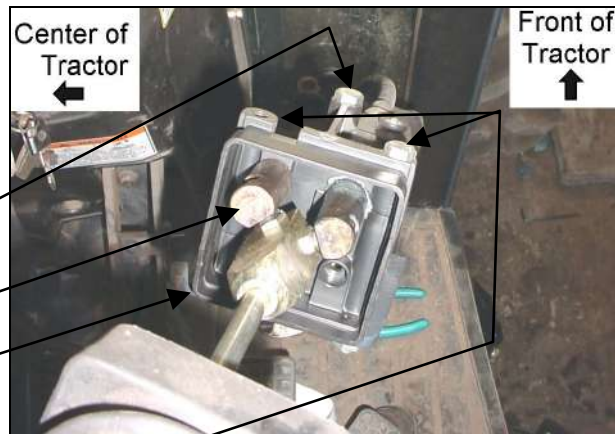

5/16"-18NC x 4" Grade 5 Hex Bolt, Lockwasher, and Hex Nut, 2 places.

3.3.17. Route cables through lower hole in cab front glass.

3.3.18. Position handle so it exposes female threads in single handle controller.

3.3.19. Install cables to single handle controller female threads and tighten cable nut.

3.3.20. Reposition single handle controller handle.

3.3.21. Secure outer portion of cables to single handle controller using single handle controller bolt.

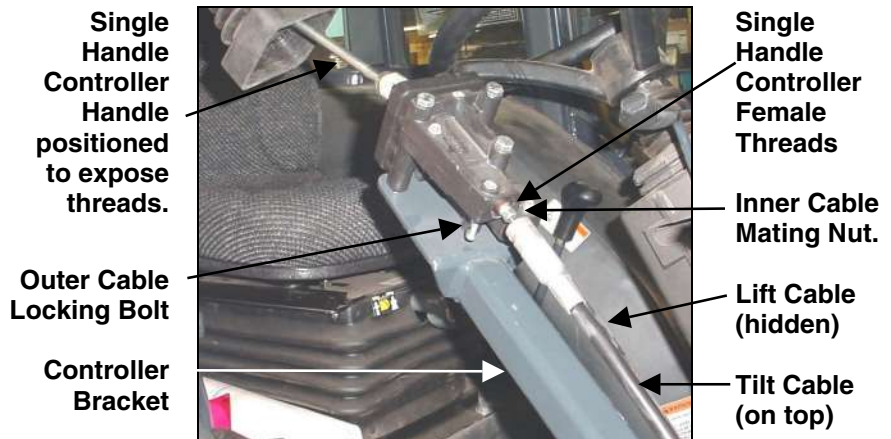

3.3.22. Install tilt cable to upper spool of valve as follows. Refer to photo and illustration below.

- A. Thread .750-16 UNF jam nut entire length of threaded hub and onto the cable.
- B. Place flange on sleeve and thread flange/sleeve assembly entire length of threaded hub and onto the cable.
- C. Thread .250-28 UNF jam nut onto cable threaded rod until it bottoms.
- D. Place connector onto threaded rod and against jam nut. Align connector so it will mate with spool terminal eye and secure jam nut against connector.
- E. Slide the connector onto spool and align the holes. Insert pin through connector and spool holes.
- F. With cable attached to valve and input device, turn the flange/sleeve assembly onto the threaded hub until it is flush with the valve face. When turning the flange/sleeve assembly, make sure that the input device remains in the neutral position.
- G. Tighten the .750-16 UNF jam nut against the sleeve to lock in position.
- H. Bring flange into position and bolt assembly to valve housing. Tighten screws sufficiently to flatten lockwashers/secure flange.

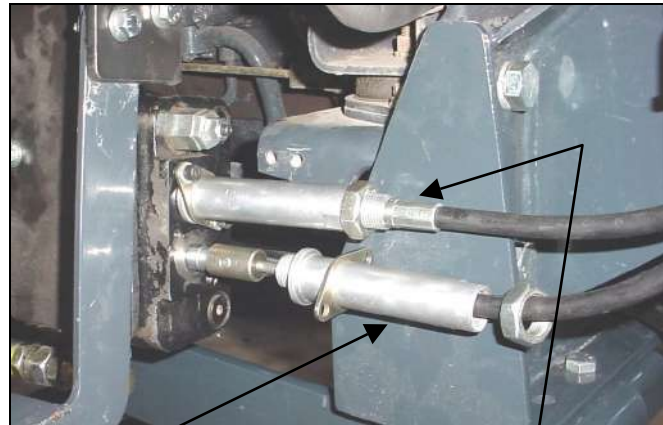

2nd Install Lift Cable to Lower Spool of Valve

1st Install Tilt Cable to Upper Spool of Valve

3.3.23. Repeat previous steps to install lift cable to lower spool of valve.

NOTE: Over-tightening will distort flange.

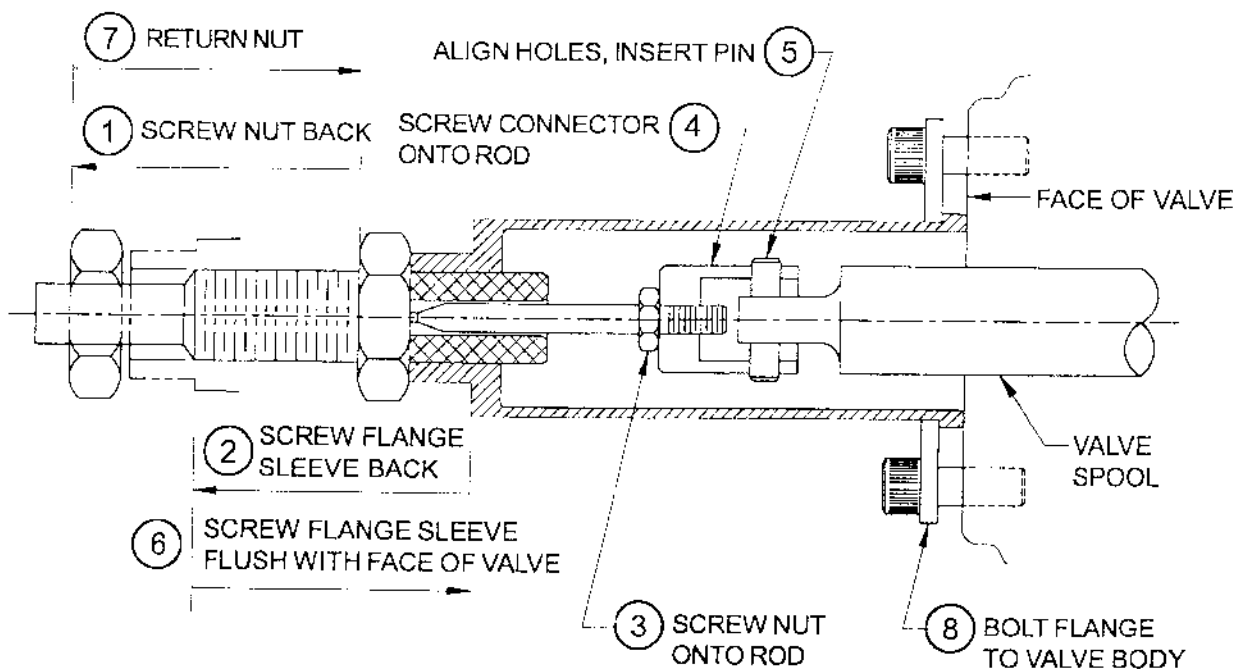

3.3.24. Adjust cables so single handle controller handle is centered, then secure cable nuts.

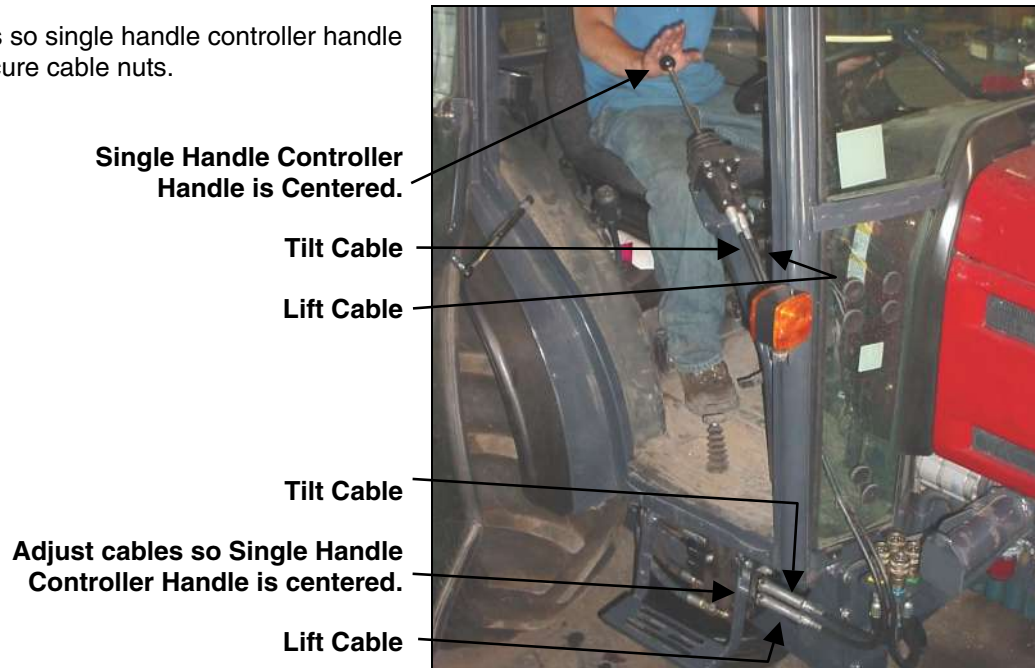

3.3.25. Connect working port hoses from loader valve to quick coupler fittings.

3.3.26. Using color nylon ties, install one on each quick coupler fitting and one on each lower hose. These color ties will allow easy identification of loader circuits when mounting and dismounting loader.

- Port "A" Tilt Cylinder Base End
 Yellow Tie
- Port "B" Tilt Cylinder Rod End
 Red Tie
- Port "D" Lift Cylinder Rod End
 Blue Tie
- Port "C" Lift Cylinder Base End
 Green Tie

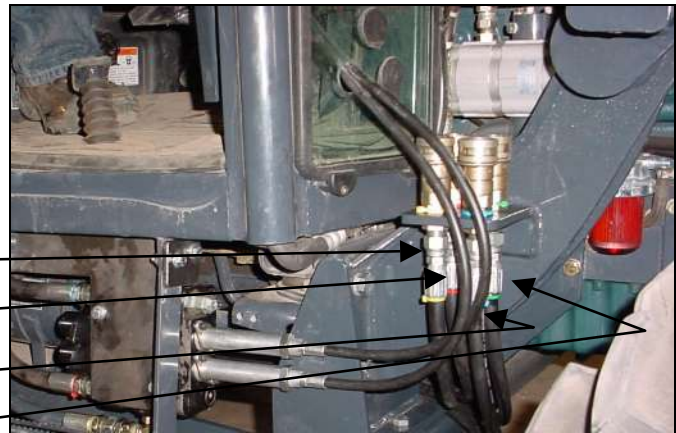

3.3.27. In full view of operator, install direction decal to cab window as shown.

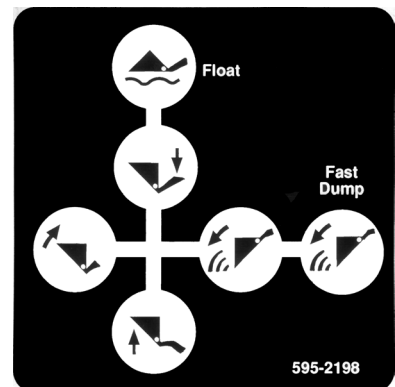
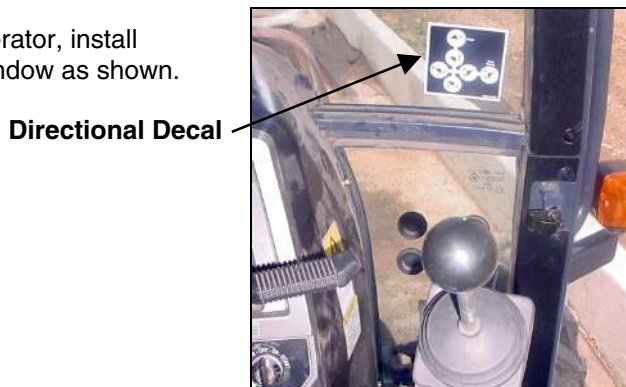

3.3.28. Check that all hydraulic connections have been tightened.

3.4. LOADER INSTALLATION

3.4.1. Remove all loader components from shipping package.



CAUTION: Lift and support all loader components safely.

IMPORTANT: Do not extend tilt cylinders without attachment pinned to loader. Failure to follow these instructions could cause loader damage and void warranty.

3.4.2. Before installing loader to tractor, use a hoist to install pin on bucket or pin on attachment and bucket or skid steer attachment and bucket on loader. Secure using pins and e-clips, 4 places.

Top Pin 1" x 4.50" and E-Clip, LH side.
Top Pin 1" x 4.75" and E-Clip, RH side.

Center hole is not used on ML114.

Bottom Pin 1" x 4.50" and E-Clip, RH & LH sides.

NOTE: Locate tilt cylinder grease zerk upward.

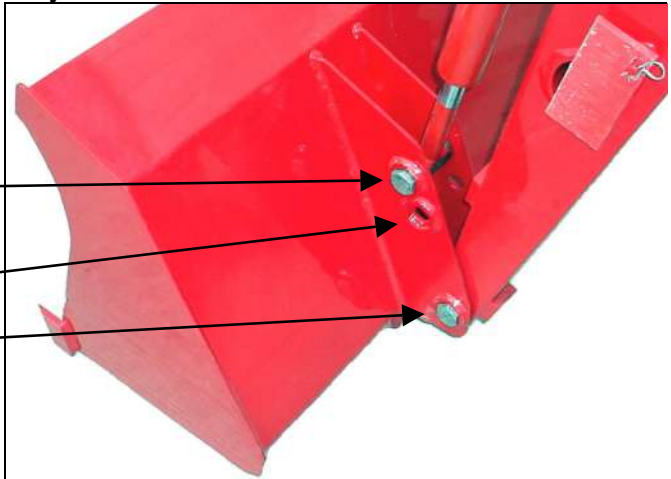

Refer to Section 10 for Pin On Bucket, page 42.

Refer to Section 11 for Pin On Bale Spear, page 43.

Refer to Section 12 for Pin On Pallet Fork, page 45.

Refer to Sections 13 to 15 for Optional Pin On Quick Attach System, pages 47 to 50.

Refer to Sections 16 to 19 for Optional Skid Steer Tool Carrier System, pages 51 to 57.

3.4.3. Following these instructions will add stability to loader package and will allow easier handling of loader with hoist.

3.4.4. Support the loader by using a hoist. Install loader to mounting brackets previously installed on tractor. Refer to Section 8 — Mounting the Loader, Pages 39 to 40.



CAUTION: Lift and support all loader components safely.

3.5. CONNECT HYDRAULICS

3.5.1. Route working port hoses from loader to quick couplers so hoses will not interfere when dismantling or mounting loader.

3.5.2. Support working port hoses in a way that will keep them from rubbing loader components thus keeping them from being damaged during loader operation.

Working Port Hoses

Quick Couplers



3.5.3. Verify all working port hose connections.

- (A) Connect Port "A" to Tilt Cylinder Base End Yellow Tie.
- (B) Connect Port "B" to Tilt Cylinder Rod End Red Tie.
- (D) Connect Port "D" to Lift Cylinder Rod End Blue Tie.
- (C) Connect Port "C" to Lift Cylinder Base End Green Tie.

- (1) Power Beyond "PB" Port.
- (2) Return "OUT" Port.
- (3) Pressure "IN" Port.
- (4) Prince Valve.

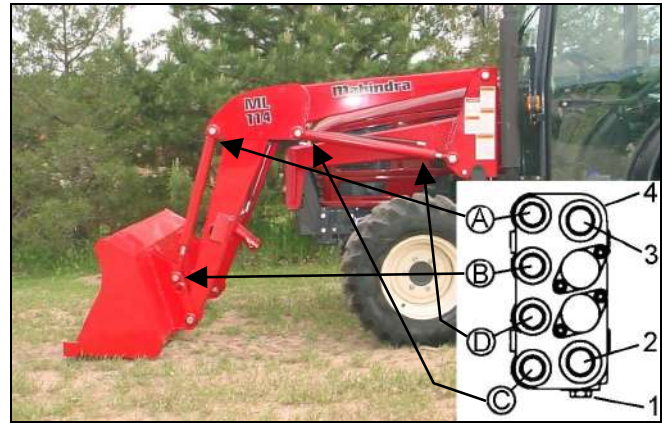

IMPORTANT: Valve Port "A" must be connected to Tilt Cylinder Base End port and Valve Port "B" must be connected to Tilt Cylinder Rod End port or else Regen Function of Valve will not work correctly.



CAUTION: When properly installed, the external valve handle will control loader hydraulic circuits as described in Item 4.4, Page 28.

3.6. BUCKET LEVEL INDICATOR

3.6.1. Install bucket level indicator rod assembly into bucket level indicator tube assembly.

3.6.2. Remove RH tilt cylinder base end pin e-clip. Position bucket level indicator tube assembly over pin. Reinstall e-clip.

3.6.3. Remove RH tilt cylinder rod end pin e-clip. Position bucket level indicator rod assembly over pin. Reinstall e-clip.



RH Tilt Cylinder
Base End
Pin and E-Clip.

Bucket Level
Indicator
Tube Assembly

Bucket Level
Indicator
Rod Assembly

RH Tilt Cylinder
Rod End
Pin and E-Clip.

4. PRE-OPERATION INSTRUCTIONS

4.1. HYDRAULIC FLUID

Check the tractor hydraulic fluid level and fill, if required.

4.2. INITIAL LOADER OPERATION

NOTE: If any loader cavitation is noticed during loader operation, check tractor hydraulic fluid level and correct.

NOTE: Keep engine speed at low idle during the initial loader operation.



CAUTION: Escaping hydraulic fluid under pressure can have sufficient force to penetrate skin, causing serious personal injury. Before disconnecting lines, be sure to relieve all pressure. Before applying pressure to system, be sure all connections are tight and that lines, tubes, and hoses are not damaged. Fluid escaping from a very small hole can be almost invisible. Use a piece of cardboard or wood, rather than hands, to search for suspected leaks. If injured by escaping fluid, see a doctor at once. Serious infection or reaction can develop if proper medical treatment is not administered immediately.

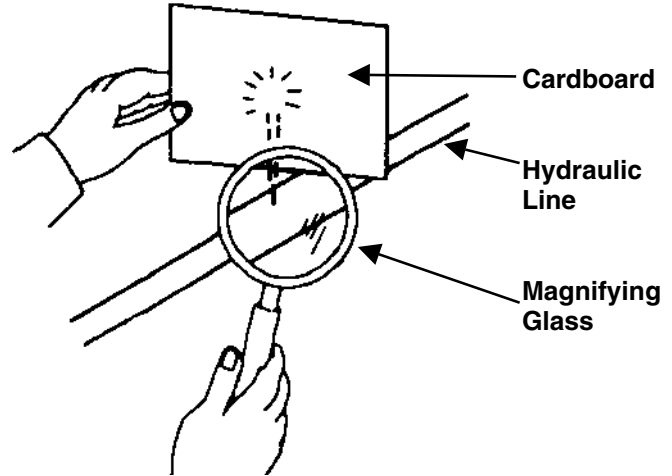

4.3. EXTERNAL LOADER VALVE



CAUTION: When properly installed, the loader valve handle will control loader hydraulic circuits as described below.

IMPORTANT: Contaminants in hydraulic fluid can cause valve spools to stick. **BE ALERT** when operating loader and follow your tractor Operator Manual hydraulic fluid maintenance schedule.

4.4. LOADER MOUNTED VALVE EQUIPPED WITH SINGLE HANDLE CONTROL

4.4.1. Your loader utilizes a tractor mounted valve equipped with a single handle controller. It will function as described.

Number 3 Position:

Push the handle full forward to activate float position.

Number 2 Position: Push the handle forward to lower loader.

Number 1 Position: Pull the handle back to raise loader.

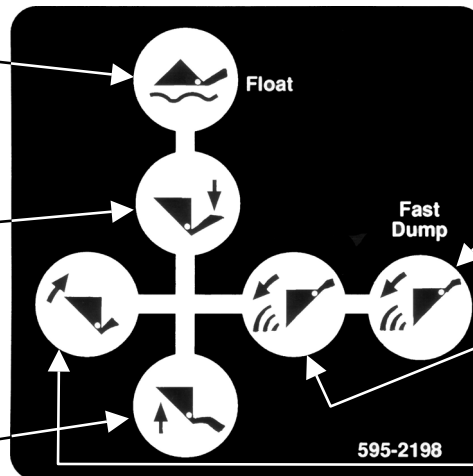

Number 6 Position:

Push the handle full outward to activate regen position which will dump attachment at a faster rate.

Number 5 Position:

Push the handle outward to dump attachment.

Number 4 Position:

Pull the handle inward to roll back attachment.

4.5. NEUTRAL POSITION

The loader external valve has a "neutral position" which prevents movement of the loader or attachment. When the valve handle is manually released from the work position, the valve spool will return to the neutral position.

4.6. FLOAT POSITION

The loader valve has a "float position" incorporated into the lift cylinder circuit which allows the loader to float. This float feature is important for satisfactory operation when scraping, sweeping, leveling, or any job where it is necessary to follow the contour of the surface. To activate float position, lower the bucket or attachment and push the valve handle all the way forward into detent. The valve will stay in float detent position until the operator manually pulls the valve handle out of detent position to deactivate float.

4.7. REGENERATIVE DUMPING POSITION

The loader valve has a "Feel Position Regenerative Spool" incorporated in the attachment spool. The tilt cylinders must be connected to this spool allowing the operator to choose normal dump or fast dump during loader operation.

NOTE: Use normal dump position when digging with loader. This will allow operator to put full tractor weight on cutting edge during this operation. The regenerative function can then be used when dumping load from bucket.

NOTE: Valve circuits must be hooked up correctly to allow regen to operate correctly.

IMPORTANT: If the bucket or attachment does not operate as indicated on the directional decal, lower the bucket to the ground, stop the engine, and relieve all hydraulic pressure. Recheck hydraulic circuit hookup to loader valve and correct.

NOTE: Use of regen function during dumping will eliminate attachment cylinder cavitation, which will reduce or eliminate any free movement of bucket or attachment during loader operation.



CAUTION: Do not tamper with relief valve setting. The relief valve is pre-set at the factory. Changing the setting can cause overloading of the loader and tractor, which may result in serious injury.

4.8. INITIAL LOADER OPERATION

NOTE: Keep engine speed at low idle during the initial loader operation.

Before operating the loader, fully raise and lower the boom two or three times. Then raise the loader bucket approximately four (4) feet above the ground and cycle the tilt cylinders two or three times. Lower the bucket or attachment to the ground. Check the tractor hydraulic fluid level and fill as required. Refer to the tractor Operator Manual for the proper hydraulic fluid and the correct hydraulic fluid level.



CAUTION: Before leaving the tractor seat, lower attachment or loader boom to ground, stop engine, lock brakes, relieve hydraulic pressure, and remove key.

IMPORTANT: Always keep the cylinders in a retracted position when the loader is not in use to guard against rust and contamination which may cause damage to the cylinder rods and hydraulic system.

4.9. REMOVING AIR FROM HYDRAULIC SYSTEM

Repeat raising and lowering the loader boom and bucket until all the air is removed from the system and the system responds properly.

Check the tractor hydraulic fluid level and fill, if required.



5. DAILY MAINTENANCE & LUBRICATION

5.1. DAILY CHECKS

5.1.1. Check all hardware daily before operation. Tighten hardware to torque values as specified in the Torque Chart, page 62 unless otherwise specified.

IMPORTANT NOTE: To prevent mounting kit hardware from loosening during operation always torque mounting kit hardware to specified torque noted in Loader Operator Manual. Check bolt torque every 50 hours of loader operation.

5.1.2. With the engine off and the bucket on the ground, inspect all hoses for cuts or wear. Check for signs of leaks and make sure all fittings are tight.



CAUTION: Escaping hydraulic fluid under pressure can have sufficient force to penetrate skin, causing serious personal injury. Before disconnecting lines, be sure to relieve all pressure. Before applying pressure to system, be sure all connections are tight and that lines, tubes, and hoses are not damaged. Fluid escaping from a very small hole can be almost invisible. Use a piece of cardboard or wood, rather than hands, to search for suspected leaks. If injured by escaping fluid, see a doctor at once. Serious infection or reaction can develop if proper medical treatment is not administered immediately.

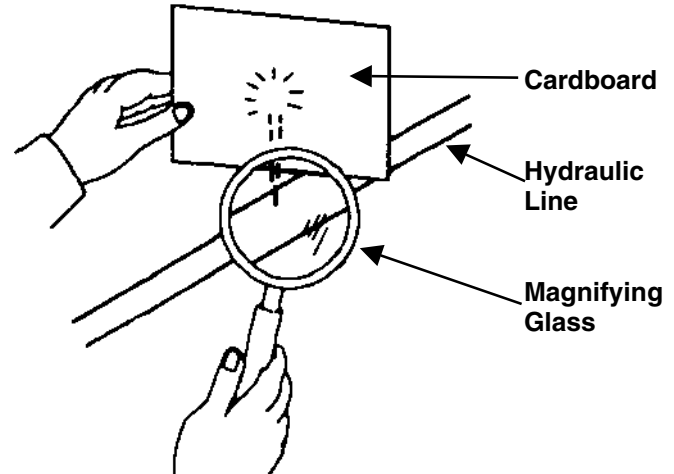

5.1.3. Service your loader at the intervals and locations as specified. When you service your loader, use only high quality lubricants. The engine hour meter on the tractor shows the amount of hours the engine has worked. Use the hour meter to service your loader at the correct time periods.

IMPORTANT: Lower the loader boom to the ground and relieve pressure in loader hydraulic lines prior to doing any service or maintenance operations on the tractor or loader.

Check the tractor hydraulic fluid level as specified in the tractor Operator Manual.

NOTE: When checking hydraulic system fluid level, the loader boom must be on the ground with the bucket or attachment resting flat on a level surface.

5.2. LOADER LUBRICATION

5.2.1. There are 12 grease fittings on this loader, one at each pivot. Lubricate pivots as specified.



CAUTION: Do not stand, walk, or work under a raised loader or attachment unless it is securely blocked or held in position. Accidental movement of the valve handle/handles or leaks in the hydraulic system could cause the loader to drop, or attachment to dump, causing severe injury.

5.2.2. Lower loader boom until bucket or attachment rests on ground, and relieve all hydraulic pressure before lubricating.

(1) Lubricate these 12 pivot points every 5 hours of operation.

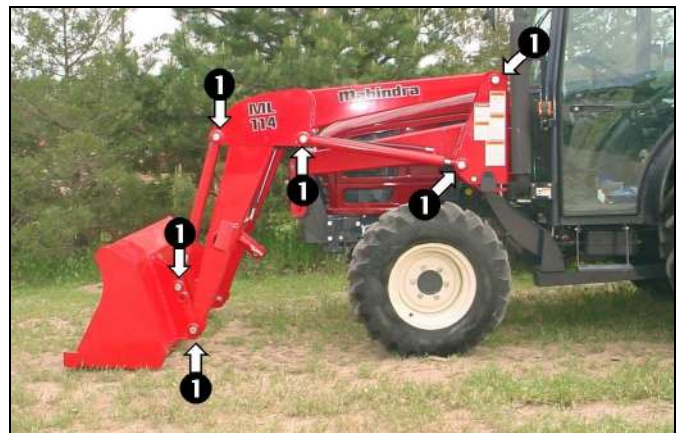

5.2.3. Before servicing your tractor, always do one of the following.

A. Park the loader off of the tractor.



B. Position loader with bucket and/or attachment level with ground, then relieve all hydraulic pressure.



CAUTION: Do not stand, walk, or work under a raised loader or attachment unless it is securely blocked or held in position. Accidental movement of valve handle/handles or leaks in the hydraulic system could cause the loader to drop, or attachment to dump, causing severe injury.

5.2.4. Clean area identified with white arrow of all material if build up occurs during operation.

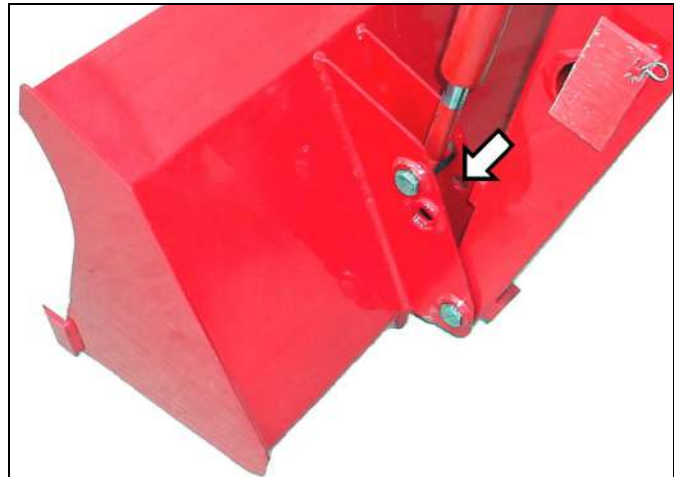

6. OPERATING INSTRUCTIONS

The loader should be operated with the tractor engine running from 1700 to 2200 rpm. Excessive speeds are dangerous, and may cause bucket spillage and unnecessary strain on the tractor and loader. When operating in temperatures below 30°F, run the tractor engine below 1200 rpm until the hydraulic fluid temperature exceeds 30°F. The following text and illustrations offer suggested loader and tractor operating techniques.

6.1. FILLING THE BUCKET

Approach and enter the pile with a level bucket. Then rollback and lift the bucket.

The rollback and lifting of the bucket will increase efficiency because a level bucket throughout the lifting cycle resists bucket lift and increases breakaway effort.

NOTE: Do not be concerned if the bucket is not completely filled during each pass. Maximum productivity is determined by the amount of material loaded in a given period of time. Time is lost if two or more attempts are made to fill the bucket on each pass.

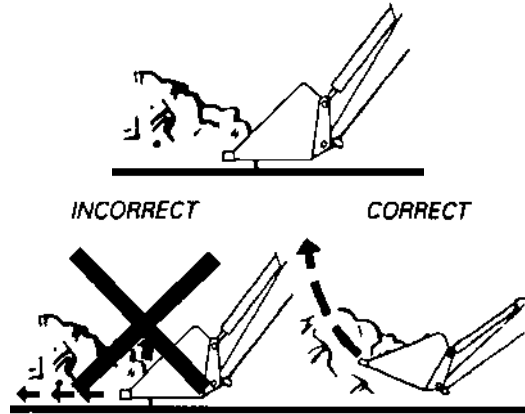

6.2. LIFTING THE LOAD

When lifting the load, keep the bucket positioned to avoid spillage.



CAUTION: Do not attempt to lift bucket or attachment loads in excess of the loader capacity.

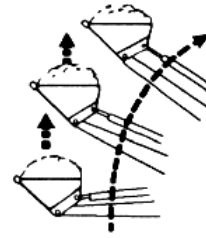

6.3. CARRYING THE LOAD

Position the loader in a low position when transporting a loaded or empty bucket or attachment. Use extreme care when operating the loader on a slope. Keep the bucket as low as possible. This keeps the bucket and tractor center of gravity low and will provide maximum tractor stability.

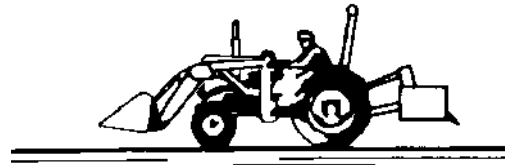

CAUTION: Operating the loader on a hillside is dangerous and is not recommended.

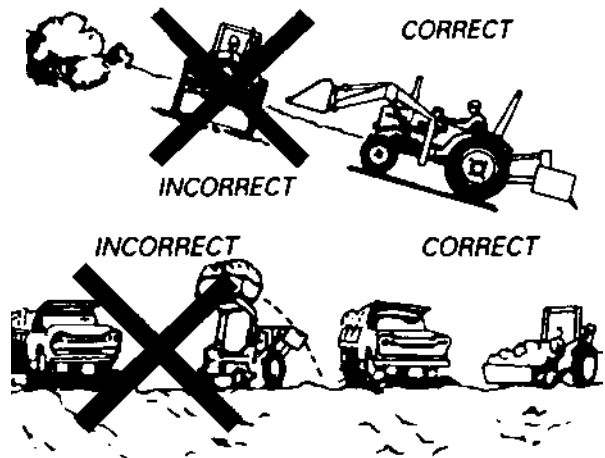

When transporting a load, keep the bucket as low as possible to avoid tipping, in case a wheel drops in a rut.

6.4. DUMPING THE BUCKET

Lift the bucket just high enough to clear the side of the vehicle. Move the tractor in as close to the side of the vehicle as possible, then dump the bucket.

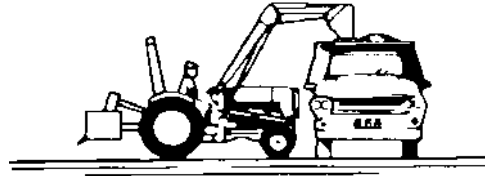

6.5. LOWERING THE BUCKET

After the bucket is dumped, back away from the vehicle while lowering and rolling back the bucket.

6.6. OPERATING WITH FLOAT CONTROL

During operation on hard surface, keep the bucket level and position the lift control in the float position to permit the bucket to float on the work surface. If hydraulic down pressure is exerted on the bucket, the cutting edge will wear faster than normal.

The float position will also avoid mixing of surface material with stockpile material. The float position will reduce the chance of surface gouging while removing snow or other material, or when working with a blade.

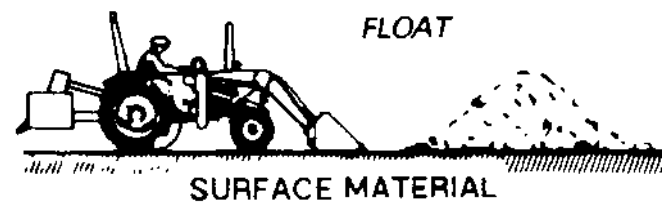
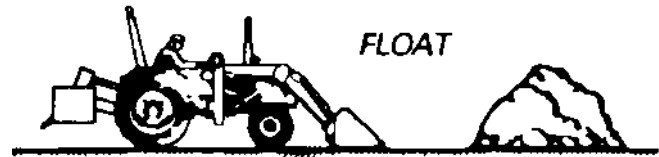

6.7. LOADING FROM A BANK

Choose a forward gear that provides a safe ground speed and power for loading.



CAUTION: Exercise caution when undercutting high banks. Dirt slides can be dangerous. Load from as low as possible for maximum efficiency. Loader lift and breakaway capacity diminish as loading height is increased.

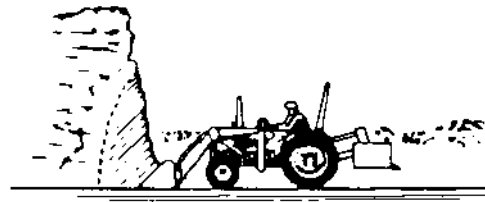

Side cutting is a good technique for cutting down a big pile.

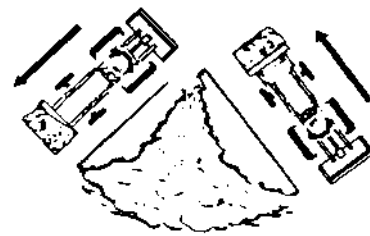

If the pile sides are too high and liable to cause cave-in, use the loader to break down the sides until a slot can be cut over the top.

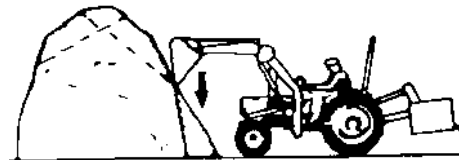

Another method for large dirt piles is to build a ramp approach to the pile.

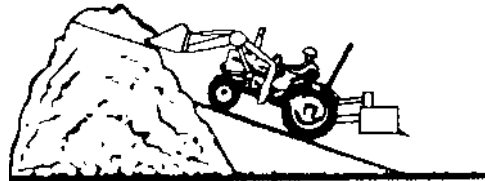

It is important to keep the bucket level when approaching a bank or pile. This will help avoid gouging the work area.

6.8. PEELING AND SCRAPING

Use a slight bucket down angle, travel forward, and hold the lift control forward to start the cut. Make a short cut and breakout cleanly.

With the bucket level, start a cut at the notch approximately 2 in. deep. Hold the depth by feathering the tilt control to adjust the cutting edge up or down. When the front tires enter the notch, adjust the lift cylinder to maintain proper depth.

Make additional passes until the desired depth is reached. During each pass, use only the tilt control while at working depth. This will allow you to concentrate on controlling the bucket angle to maintain a precise cut.

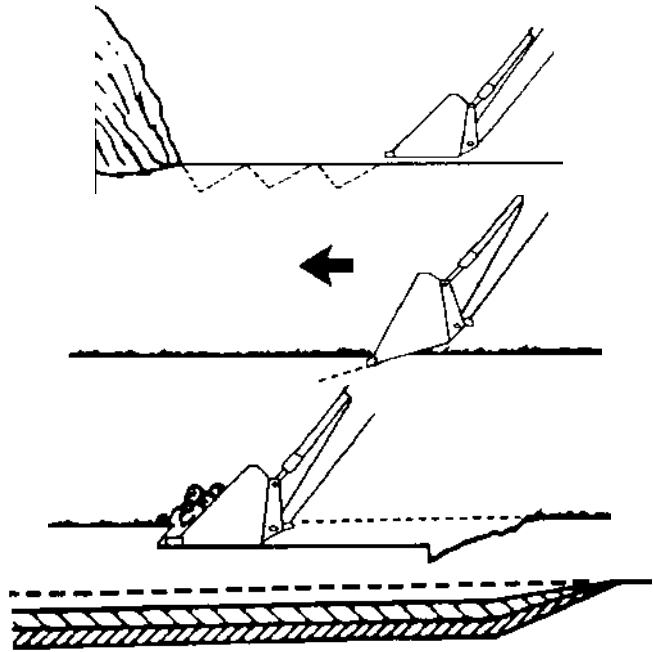

6.9. LOADING LOW TRUCKS OR SPREADERS FROM A PILE

For faster loading, minimize the angle of turn and length of run between pile and spreader.

Back grade occasionally with a loaded bucket to keep the work surface free of ruts and holes. Also, hold the lift control forward so the full weight of the bucket is scraping the ground. Use the heel of the bucket.

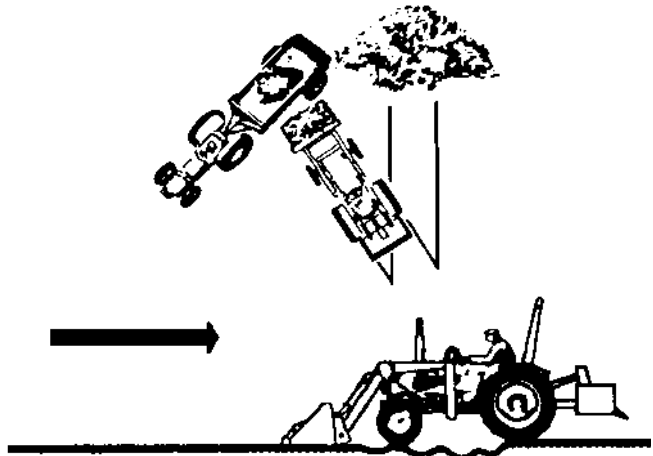

6.10. BACKFILLING

Approach the pile with the bucket flat.

Poor operating methods actually move no more dirt and make it more difficult to hold a level grade. Do not use the bucket in the dumped position for bulldozing. This method will impose severe shock loading on the dump-linkage, the tilt cylinders, and the tractor.

Leave dirt in the bucket because dumping on each pass wastes time.

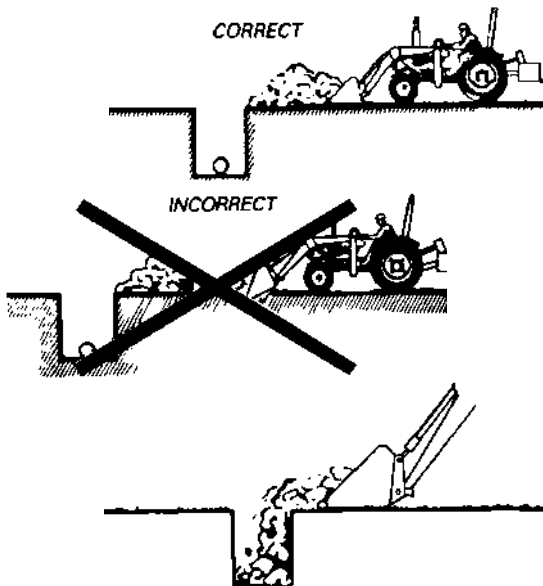

Operate at right angles to the ditch, take as big a bite as the tractor can handle.

Leave dirt that drifts over the side of the bucket for final clean up.

Pile dirt on the high side for easier backfilling on a slope.

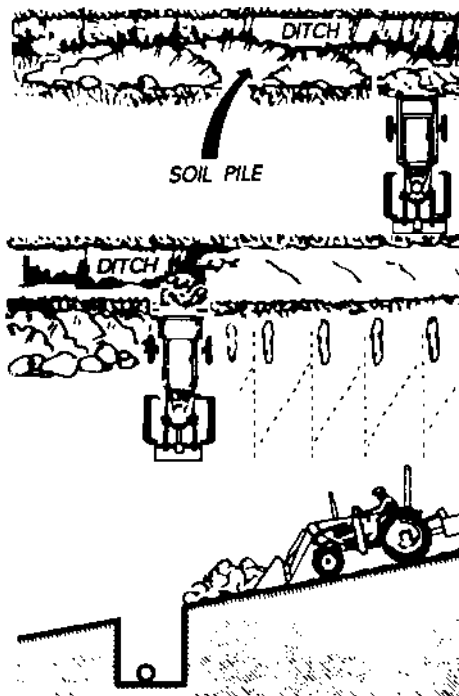

6.11. HANDLING LARGE HEAVY OBJECTS

CAUTION: Handling large heavy objects can be extremely dangerous due to:



- Danger of rolling the tractor over.
- Danger of upending the tractor.
- Danger of object rolling or sliding down the loader boom onto the operator.

CAUTION: If you must perform the above work, protect yourself by:



- Never lifting the load higher than necessary to clear the ground when moving.
- Adding rear ballast to the tractor to compensate for the load.
- Never lifting large objects with equipment that does not have an anti-rollback device.
- Moving slowly and carefully; avoiding rough terrain.

6.12. BACK GRADING

When back grading, the angle between the bottom of the bucket and the ground must not be more than 15 degrees. Failure to follow these instructions could cause loader tilt cylinders to fail and void warranty.



7. DISMOUNTING THE LOADER



CAUTION: Always park loader with material bucket attached to the loader.



CAUTION: Before leaving the tractor seat, lower attachment or loader boom to ground, stop engine, lock brakes, relieve hydraulic pressure, and remove key.



CAUTION: Do not stand, walk, or work under a raised loader or attachment unless it is securely blocked or held in position. Accidental movement of valve handle/handles or leaks in the hydraulic system could cause the loader to drop, or attachment to dump, causing severe injury.



CAUTION: Do not allow bystanders in loader work area.

IMPORTANT: Never allow weight of tractor to be placed on parking stand when mounting or dismounting loader.

7.1.1. Position the loader on a hard level surface. The more level the surface the easier the loader is to mount and dismount.

7.1.2. Raise loader, dump bucket over, and then lower loader so that bucket cutting edge is resting on ground.

Bearing Box
Center Bracket
Cutting edge of bucket resting on ground.



7.1.3. Remove parking stand from storage position in boom crosstube. Return hairpin cotter to storage position.

Hairpin Cotter in Storage Position.
Parking Stand in Storage Position.
Parking Stand Receiver.
Clevis Pin and Hairpin Cotter in Park Position.

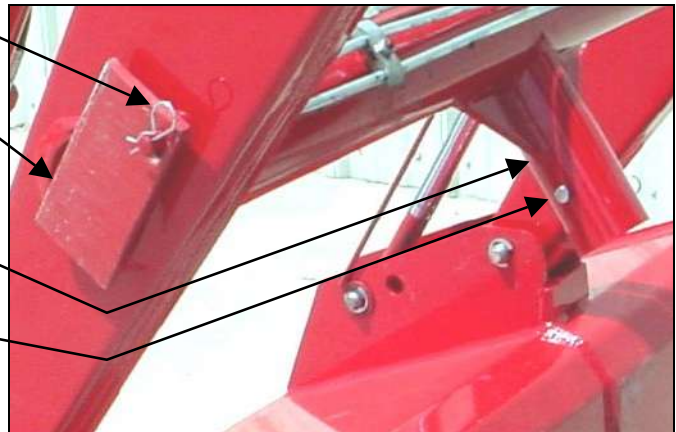

7.1.4. Position parking stand in parking stand receiver on center of boom arm crosstube. Secure using clevis pin and hairpin cotter.

Hairpin Cotter in Storage Position.
Parking Stand Receiver.
Clevis Pin and Hairpin Cotter in Park Position.
Parking Stand in Park Position.

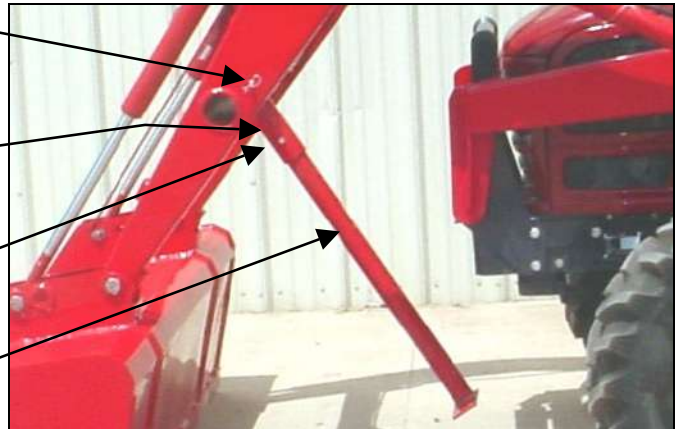

7.1.5. Extend lift cylinders to raise loader. Retract tilt cylinders to roll bucket back. Retract lift cylinders to lower loader boom down until parking stand makes firm contact with ground. Extend tilt cylinders until bucket cutting edge just touches the ground.

NOTE: Driving the tractor forward slowly while positioning loader will allow parking stand to contact ground firmly.

Parking Stand contacting ground firmly.



7.1.6. Remove hex nuts, lockwashers, and flatwashers from t-bolts. Swing hinge assemblies clear of center brackets.

7.1.7. Install washers and nuts back on t-bolts to protect threads when mounting and dismounting loader.

Center Bracket

Hinge Assembly

Hex Nut, Lockwasher, Flatwasher, and T-Bolt

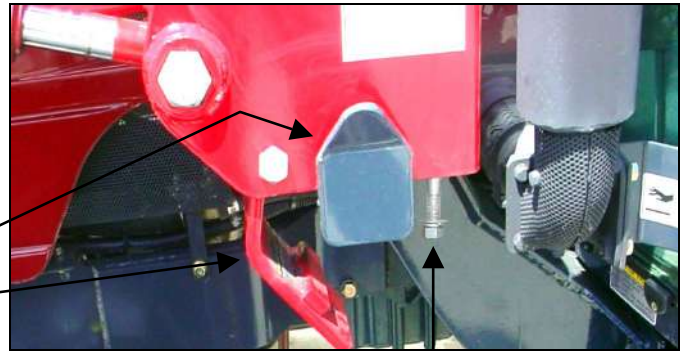

7.1.8. Position loader valve in float position.

7.1.9. Slowly retract tilt cylinders until loader lifts off center mounting brackets.

7.1.10. Retract lift cylinders.



7.1.11. Make sure all loader components will clear tractor.

7.1.12. Observe the four (4) working port hoses to ensure they will not be caught or stretched when backing away from loader.

7.1.13. Back the tractor up slowly until subframe front crosstube is just clear of front mount.

Loader Subframe Front Crosstube.



7.1.14. Stop tractor engine. Work single lever control handle to relieve hydraulic fluid pressure in lines. Refer to tractor operator manual for additional information.

7.1.15. Disconnect loader hoses from quick couplers.



7.1.16. Start tractor engine. Slowly back tractor away from the loader.



IMPORTANT: To avoid hydraulic hose damage, be alert and make sure hoses do not catch on tractor and/or loader during mounting or dismounting.



WARNING: Make sure parked loader is on a hard level surface. Engage all safety devices to prevent loader from falling and being damaged or injuring someone. Do not repair loader if it is not mounted on the tractor. Loss of hydraulic fluid or removal of parts could cause loader to collapse resulting in injury.

8. MOUNTING THE LOADER



CAUTION: Do not stand, walk, or work under a raised loader or attachment unless it is securely blocked or held in position. Accidental movement of valve handle/handles or leaks in the hydraulic system could cause the loader to drop, or attachment to dump, causing severe injury.



CAUTION: Do not allow bystanders in loader work area.

8.1.1. Slowly drive tractor forward until loader hoses can be connected to the quick couplers.



8.1.2. Stop tractor engine. Connect the loader hydraulic hoses to the correct couplers matching color ties.



8.1.3. Start tractor engine. Slowly drive tractor forward to securely position subframe front crosstube into tractor front mount.

Note: Activate the tilt and lift cylinders as required to align the subframe front crosstube with tractor front mount.

Loader Subframe Front Crosstube.

Tractor Front Mount.



8.1.4. Shift control valve lift cylinder spool into the "float" position.



8.1.5. With the subframe secure in the front mount, extend tilt cylinders to lower loader onto center brackets.

**Loader Subframe Front Crosstube
secure in Loader Front Mount.**

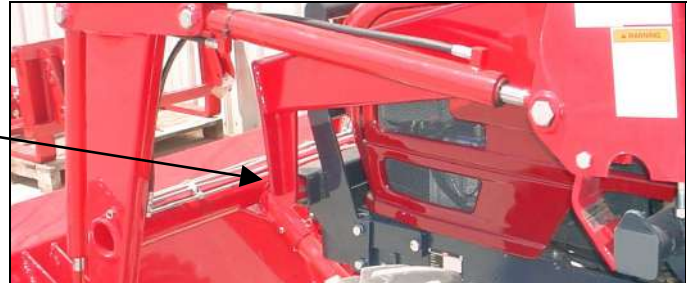

8.1.6. Remove nuts and washers from t-bolts. Swing hinge assemblies up and align with t-bolt. Reinstall flatwasher, lockwasher, and hex nut to t-bolt and tighten, 2 places.

Center Bracket
Hinge Assembly
**Flatwasher, Lockwasher,
Hex Nut and T-Bolt, 2 places.**



8.1.7. Extend lift cylinders to raise loader off the ground. Extend tilt cylinders to dump bucket over. Retract lift cylinders to rest bucket cutting edge on ground.



8.1.8. Remove parking stand from park position. Return clevis pin and hairpin cotter to parking stand receiver for storage.

8.1.9. Return parking stand to storage position. Secure using hairpin cotter.

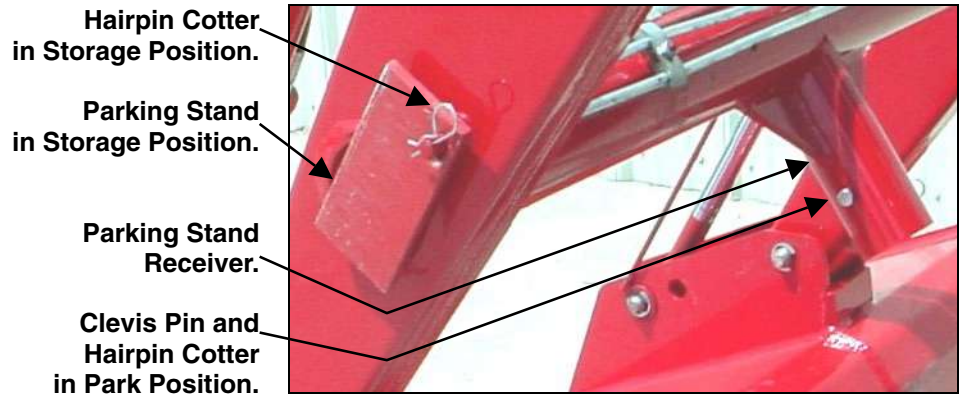

IMPORTANT: To avoid hydraulic hose damage, be alert and make sure hoses do not catch on tractor and/or loader during mounting or dismounting.

9. OPTIONAL GRILL GUARD

9.1. INSTALLATION INSTRUCTIONS

9.1.1. Tighten weight bracket bottom bolt securely.

NOTE: Tightening bottom bolt before removing front bolts will insure mounting holes remain aligned.

9.1.2. Remove front two bolts from weight bracket or front mount.

9.1.3. Locate grill guard over front mount or over grill guard spacers to weight bracket. Install 14mm x 50mm hardware in these holes.

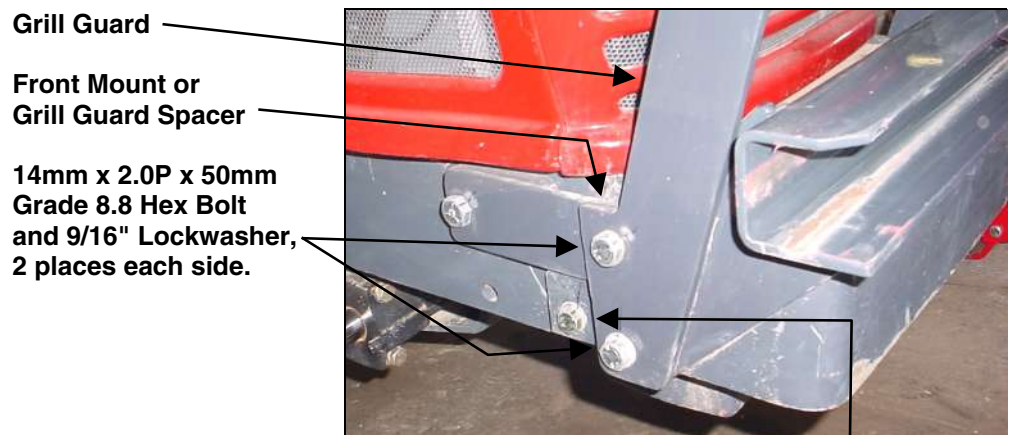

1st – Tighten Bottom Bolt Securely.

10. BUCKET– PIN ON or SKID STEER

IMPORTANT: Read safety information in this section and on decals before operating attachments.

WARNING: To avoid serious injury or death from large round or square hay bale handling:



- Use only Factory bale spear or bale retaining device handler attachment when handling round bales.
- Do not handle large square bales without a retaining device handler attachment
- Do not use buckets, forks, or other attachments without bale retaining devices.
- Do not use loader for handling large, heavy objects such as logs, tanks, etc.

WARNING: To avoid serious injury or death, realize handling large heavy objects can be extremely dangerous due to:



- Danger of rolling the tractor over.
- Danger of upending the tractor.
- Danger of the object rolling or sliding down the loader arms onto the operator.

WARNING: To avoid serious injury or death:



- Do not lift or carry anyone on buckets, forks, probes, or any other portion of the loader or loader attachments.
- Avoid contact with electrical power lines by loader or attachment



WARNING: Inadvertent movement of the loader or attachment could result in serious injury or death.

10.1. INSTALLATION INSTRUCTIONS TO SKID STEER TOOL CARRIER

IMPORTANT: Refer to Pages 54 to 56 for instructions concerning Installing Attachment to Skid Steer Tool Carrier.

IMPORTANT: Refer to Page 57 for instructions concerning Removing Attachment from Skid Steer Tool Carrier.

10.2. INSTALLATION INSTRUCTIONS TO PIN ON QUICK ATTACH

IMPORTANT: Refer to Pages 48 to 49 for instructions concerning Installing Attachment to Pin On Quick Attach.

IMPORTANT: Refer to Page 50 for instructions concerning Removing Attachment from Pin On Quick Attach.

10.3. INSTALLATION INSTRUCTIONS DIRECT TO LOADER

10.3.1. Install pin on bucket direct to loader. Secure using pins and e-clips.

NOTE: Clean area identified with white arrow of all material if build up occurs during operation.

Top Pin 1" x 4.50" and E-Clip, LH side.
Top Pin 1" x 4.75" and E-Clip, RH side.

Center hole is not used on ML114.

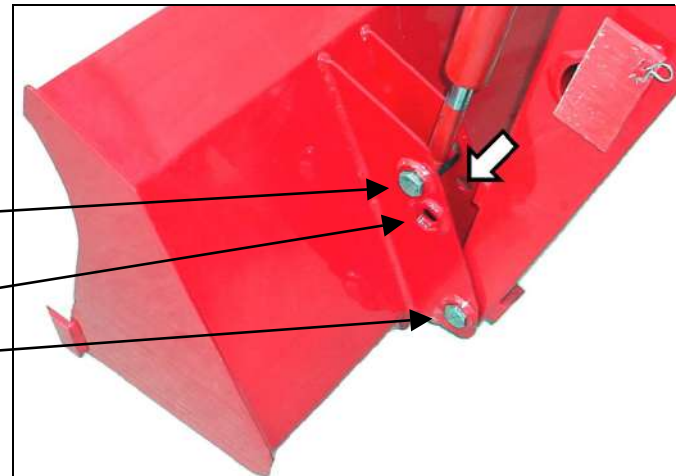

Bottom Pin 1" x 4.50" and E-Clip, RH & LH sides.

NOTE: Locate tilt cylinder grease zerk upward.

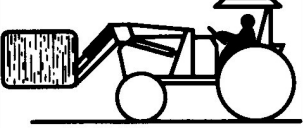

11. BALE PROBE – PIN ON or SKID STEER

CAUTION

To avoid serious injury or death:

- Read operators manual and decals before operating. Follow all safety, operating, and service instructions. Contact dealer for replacement.
- Be careful during loading, transporting, and stacking to minimize rolling bales and tractor tip over.
- ROPS (Roll-Over Protective Structures) and seat belt equipped tractors are recommended for operator use in all bale probe operations.
- Do not allow riders on tractor, loader, or bale probe.
- Avoid loading/unloading bales on sloping or uneven surfaces.
- Avoid transporting with bales raised high. Keep bales tilted back and low to the surface while moving.
- Approach, penetrate, and transport bales at low speeds. Reduce speeds on curves, hills, rough ground, or when turning.
- Do not lift anything with bale probe except round bales.
- Never raise round bale to full height with bale probe rolled back.
- Park and store bale probe points pointed against bale, building, or other stable object.

0595-3049

IMPORTANT: Read safety information in this section and on decals before operating attachments.

DANGER



To avoid serious injury or death:

- Unload only on a level surface.
- Keep bystanders clear of work area when loading and unloading bales.

0595-3050

CAUTION

To prevent bodily injury and loader instability when detaching loader, equip loader with a material bucket or a manure fork.

0595-2190



NOTE: Clean area identified with white arrow of all material if build up occurs during operation.

IMPORTANT: It is not recommended that loader be detached with bale spear attached. Loaders will park safely; however, bale spear could be damaged during parking. Always detach loader with bucket or other loader Factory approved attachment attached.



CAUTION: When transporting a round bale, tilt the bale spear slightly back from level and carry the load in a low position.



CAUTION: Never raise round bale to full height with bale spear rolled back as serious injury or death could occur.



CAUTION: To prevent bodily injury, park and store bale spear with points pointed against bale, building, or other stable object.

11.1. BALE PROBE

IMPORTANT: This spear should not be welded or heat treated.

IMPORTANT: Maximum load limit on combined pair of bale spears is 2000 pounds.

11.2. ASSEMBLY INSTRUCTIONS

11.2.1. Install shorter 950mm Bale Spear into upper sleeve and secure with nut. Torque nut 330 ft. lb.

(1) Shorter 950mm Upper Spear.

(2) Hex Nut 22mm x 2.5P for Upper Spear.
Torque nut to 330 ft. lb.

11.2.2. Install longer 1250mm Bale Spear into lower sleeve and secure with nut. Torque nut 515 ft. lb.

(3) Longer 1250mm Lower Spear.

(4) Hex Nut 28mm x 3.0P for Lower Spear.
Torque nut to 515 ft. lb.

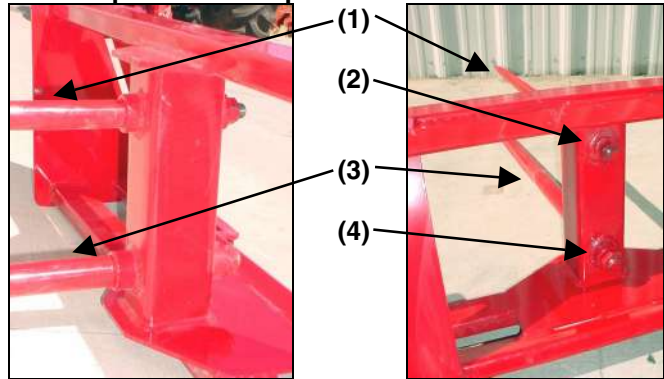

NOTE: Failure to follow these instructions could cause damage to spear and void your warranty.

NOTE: Flat side of spear should be located upward.

11.3. INSTALLATION INSTRUCTIONS TO SKID STEER TOOL CARRIER

IMPORTANT: Refer to Pages 54 to 56 for instructions concerning Installing Attachment to Skid Steer Tool Carrier.

IMPORTANT: Refer to Page 57 for instructions concerning Removing Attachment from Skid Steer Tool Carrier.

11.4. INSTALLATION INSTRUCTIONS TO PIN ON QUICK ATTACH

IMPORTANT: Refer to Pages 48 to 49 for instructions concerning Installing Attachment to Pin On Quick Attach.

IMPORTANT: Refer to Page 50 for instructions concerning Removing Attachment from Pin On Quick Attach.

11.5. INSTALLATION INSTRUCTIONS DIRECT TO LOADER

11.5.1. Install pin on bale spear direct to loader.
Secure using pins and e-clips.

Top Pin 1" x 4.50" and E-Clip, LH side.
Top Pin 1" x 4.75" and E-Clip, RH side.

Center hole is not used on ML114.

Bottom Pin 1" x 4.50" and E-Clip, RH & LH sides.

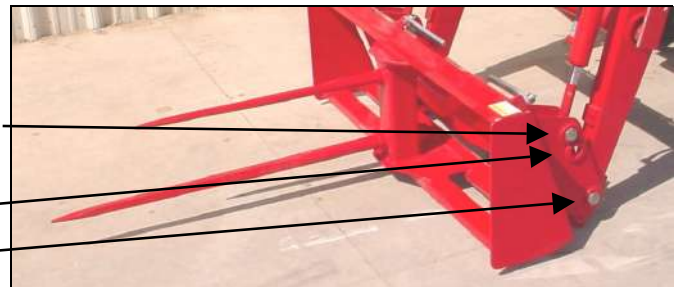

NOTE: Locate tilt cylinder grease zerk upward.

11.6. OPERATING INSTRUCTIONS

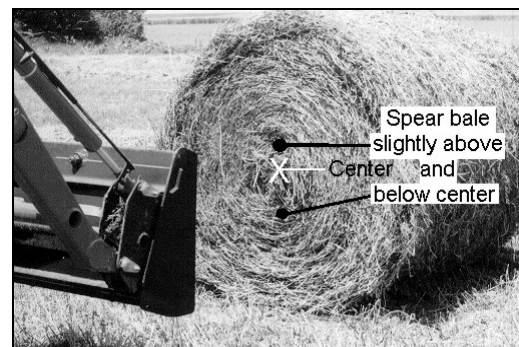

11.6.1. With bale spear level with ground, slowly spear bale slightly above and below center.

11.6.2. With both spears completely engaged into bale, tilt bale spear slightly back from level and transport the load in a low position.



12. PALLET FORK – PIN ON or SKID STEER

IMPORTANT: Read safety information in this section and on decals before operating attachments.

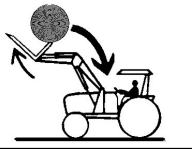
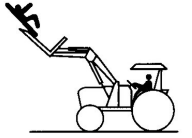
	 WARNING	<ul style="list-style-type: none">• Always keep pallet forks level when raising loads.• Avoid raising loads to full heights with pallet forks rolled back.• ROPS (Roll-Over Protective Structures) and seat belt equipped tractors are recommended for operator use in all pallet fork operations.• Do not lift or carry anyone on buckets, forks, probes, or any other portion of the loader or loader attachments.• Do not allow riders on tractor, loader, or forks.• Avoid contact with electrical power lines by loader or attachments.
	To avoid serious injury or death: <ul style="list-style-type: none">• Do not use pallet fork attachment to lift large objects, round bales, or items that may roll or slide down loader arms onto the operator.• Never operate pallet fork without attaching plate guard.• Keep loads below pallet forks attaching plate guard heights.• Always transport loads with pallet forks low and level to ground.	
		

0595-3052

 CAUTION
Maximum load limit on combined pair of forks is 5700 pounds.
0595-3053

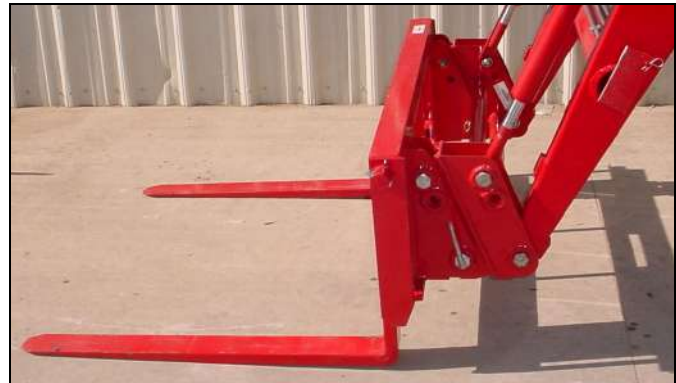

 CAUTION
To prevent bodily injury and loader instability when detaching loader, equip loader with a material bucket or a manure fork.
0595-2190

 **WARNING:** The pallet fork attachment is specifically designed to engage and load palletized materials. Do not use forks to handle large loads such as bales, posts, etc. as they can fall or roll back onto operator causing serious injury or death.

 **CAUTION:** Maximum load limit on combined pair of forks is 5700 pounds.

12.1. SKID STEER PALLET FORK

12.1.1. The Skid Steer Pallet Fork has two forks each 1-1/2" x 4" x 42".

12.2. ASSEMBLY INSTRUCTIONS

12.2.1. Install forks to pallet fork frame using pins, 2 places secure using 3/8" x 2-1/2" bolts, lockwashers, and nuts, 4 places.

Pallet Fork Frame.
Forks, 2 places.
Pins, 2 places.
3/8" x 2-1/2" Bolts, Lockwashers,
and Nuts, 4 places.

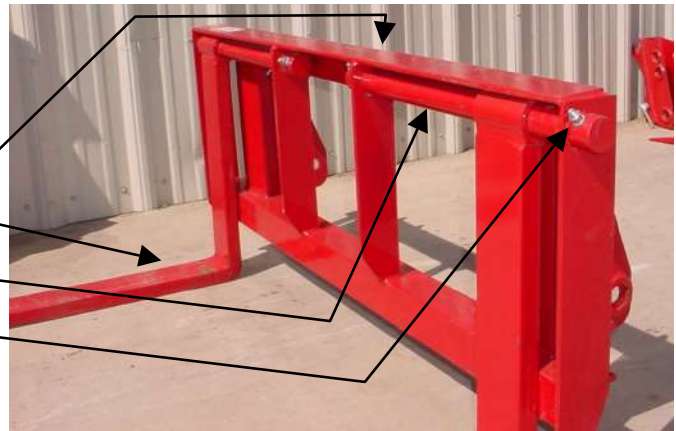

12.3. INSTALLATION INSTRUCTIONS TO SKID STEER TOOL CARRIER

IMPORTANT: Refer to Pages 54 to 56 for instructions concerning Installing Attachment to Skid Steer Tool Carrier.

IMPORTANT: Refer to Page 57 for instructions concerning Removing Attachment from Skid Steer Tool Carrier.

12.4. INSTALLATION INSTRUCTIONS TO PIN ON QUICK ATTACH

IMPORTANT: Refer to Pages 48 to 49 for instructions concerning Installing Attachment to Pin On Quick Attach.

IMPORTANT: Refer to Page 50 for instructions concerning Removing Attachment from Pin On Quick Attach.

12.5. INSTALLATION INSTRUCTIONS DIRECT TO LOADER

12.5.1. Install pin on pallet fork direct to loader.
Secure using pins and e-clips.

Top Pin 1" x 4.50" and E-Clip, LH side.
Top Pin 1" x 4.75" and E-Clip, RH side.

Center hole is not used on ML114.

Bottom Pin 1" x 4.50" and E-Clip, RH & LH sides.

NOTE: Locate tilt cylinder grease zerk upward.

NOTE: Optional Pin On Quick Attach shown.

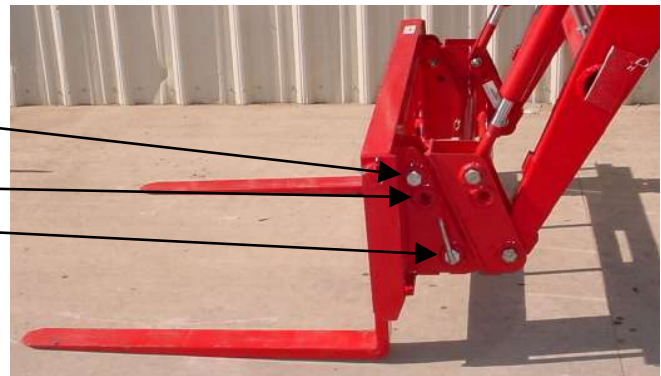

12.6. OPERATING INSTRUCTIONS

The operator must keep the load centered and as far back on the forks as possible. Operator must always keep load level. Carry the load low and at a slow speed.

12.7. LOADER PARKING INSTRUCTIONS

12.7.1. Never park loader off of tractor without material bucket attached to loader.

13. OPTIONAL PIN ON QUICK ATTACH SYSTEM

IMPORTANT: Read safety information in this section and on decal before operating attachment.



WARNING

Do not operate without confirmation that coupler pins are fully engaged. Loader attachment can fall off if not properly attached.

To avoid serious injury or death:

- Only use loader manufacturer approved attachments.
- Read all operators manuals and decals before operating. Follow all safety, operating, and service instructions. Contact dealer for replacement parts.

0595-3051

NOTE: Pin On Quick Attach System is optional equipment



WARNING: Always read and follow operating instructions before operating Pin On Quick Attach System.

13.1. RECOMMENDED LOADER FACTORY APPROVED ATTACHMENTS

IMPORTANT: Use only Loader Factory Approved Attachments for mounting on this Pin On Quick Attach System.

13.2. PIN ON QUICK ATTACH



WARNING: Always read and follow operating instructions before operating Pin On Quick Attach System.

13.2.1. Install pin on quick attach direct to loader. Secure using pins and e-clips.

Top Pin 1" x 4.50" and E-Clip, LH side.
Top Pin 1" x 4.75" and E-Clip, RH side.

Center hole is not used on ML114.

Bottom Pin 1" x 4.50" and E-Clip, RH & LH sides.

NOTE: Locate tilt cylinder grease zerk upward.

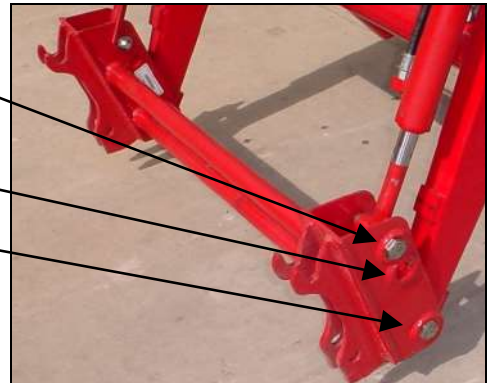

14. INSTALLING BUCKET OR ATTACHMENT TO PIN ON QUICK ATTACH



CAUTION: Before leaving the tractor seat, stop the engine and lock brakes when installing or removing bucket or attachment.



CAUTION: Do not stand, walk, or work under a raised loader or attachment unless it is securely blocked or held in position. Accidental movement of valve handle/handles or leaks in the hydraulic system could cause the loader to drop, or attachment to dump, causing severe injury.

14.1. RECOMMENDED LOADER FACTORY APPROVED ATTACHMENTS

14.1.1. Use only the following Loader Factory Approved Attachments for mounting on this Pin On Quick Attach System.

- ◆ Pin On Bucket 54"
- ◆ Pin On Bucket 60"
- ◆ Pin On Bucket 66"
- ◆ Pin On Bucket 72"
- ◆ Pin On Bucket 78"
- ◆ Pin On Bale Spear
- ◆ Pin On Pallet Fork

14.2. KEEP THESE AREAS CLEAN

14.2.1. Keep these areas clean to allow pin on quick attach system to function properly.

IMPORTANT: To maintain your Pin On Quick Attach System functioning properly, always inspect Pin On Quick Attach System components for damage or wear. If damage or wear exists, replace components immediately.



14.3. OPERATING INSTRUCTIONS

14.3.1. Install top pin only to bucket or attachment. Secure using pins and e-clips.

- Quick Attach Receiver
- Top Pin 1" x 4.50" and E-Clip, LH & RH side.
- Center hole is not used on ML114.

14.3.2. To attach bucket or attachment to loader, lower loader boom to ground with pin on quick attach rolled forward slightly.

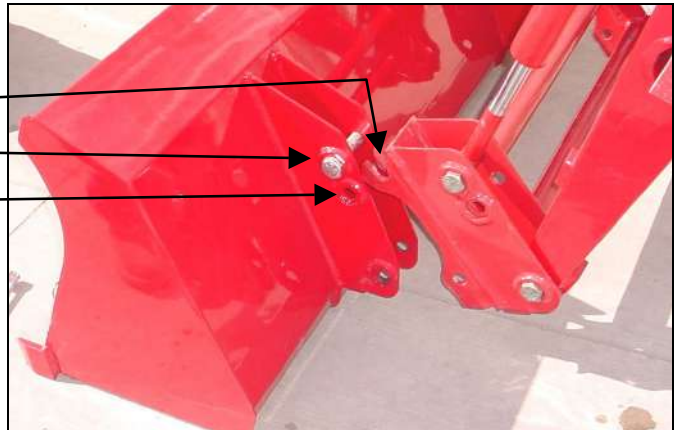

14.3.3. Roll quick attach forward by extending tilt cylinders just enough to allow pin on quick attach receiver to engage bucket or attachment upper pin. Drive tractor forward, aligning quick attach with bucket or attachment.

Bucket or Attachment Upper Pin
Quick Attach Receiver – align with bucket or attachment upper pin.
Quick Attach Attachment

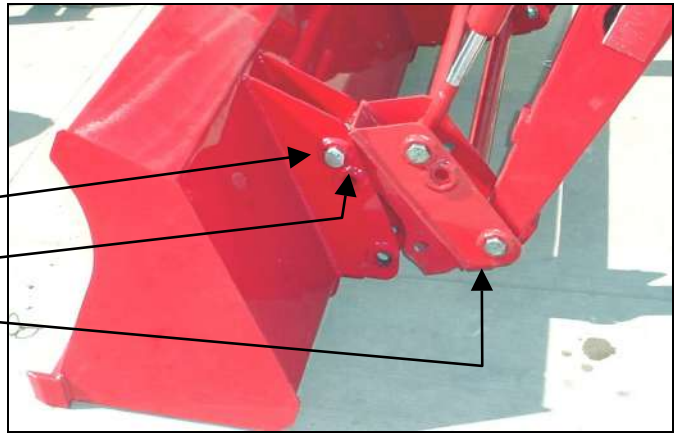

14.3.4. When pin on quick attach is aligned with pin on bucket or attachment, raise loader boom slowly making sure pin on quick attach engages attachment then roll attachment back.

Pin On Bucket or Attachment against Pin On Quick Attach.
Lynch Pin (not yet installed).
Handle Pin (not yet installed).

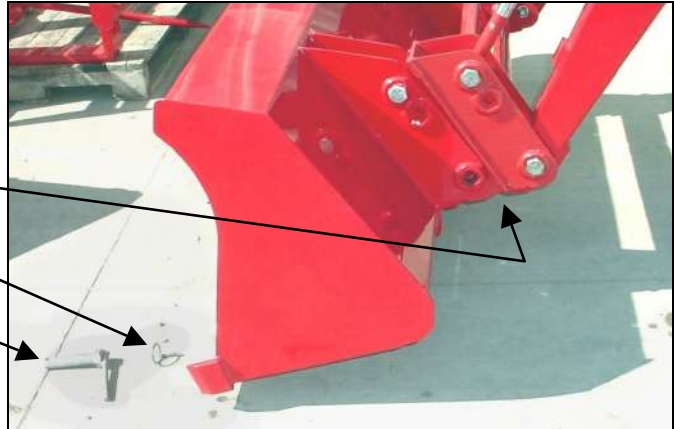

14.3.5. Install handle pin and secure with lynch pin, 2 places.

Handle Pin and Lynch Pin, 2 places.

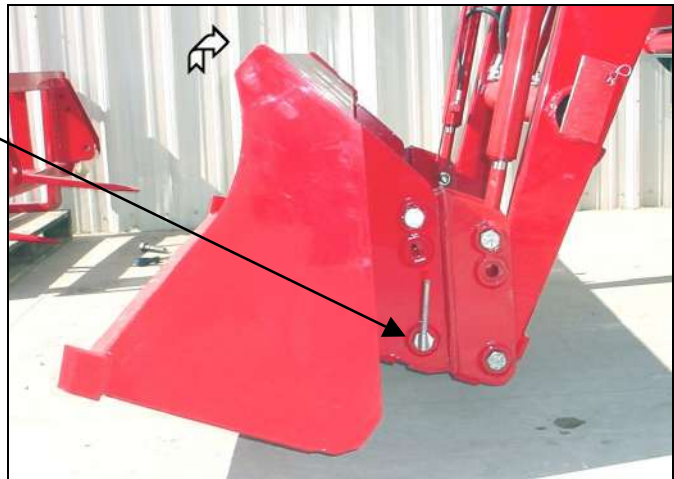

WARNING: A bucket or attachment that is not securely locked into Pin On Quick Attach could come off during loader operation causing serious injury or death.

15. REMOVING BUCKET OR ATTACHMENT FROM PIN ON QUICK ATTACH



CAUTION: Before leaving the tractor seat, stop the engine and lock brakes when installing or removing bucket or attachment.



CAUTION: Do not stand, walk, or work under a raised loader or attachment unless it is securely blocked or held in position. Accidental movement of valve handle/handles or leaks in the hydraulic system could cause the loader to drop, or attachment to dump, causing severe injury.

15.1. OPERATING INSTRUCTIONS

15.1.1. Position loader so attachment is approximately 1" off ground.

15.1.2. Remove lynch pins and handle pins.

Handle Pin and Lynch Pin, 2 places, (to be removed).

Positioned approx. 1" Off Ground

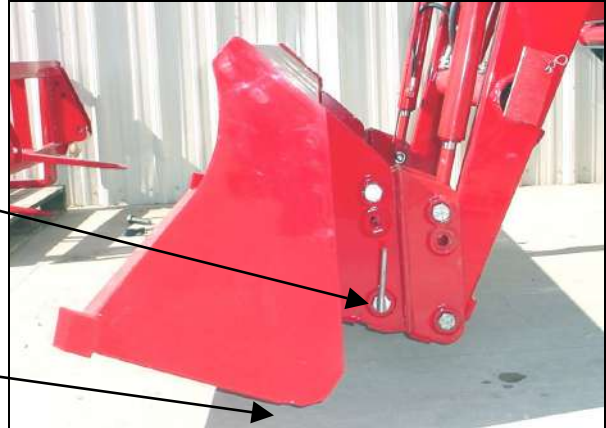

15.1.3. Roll bucket or attachment forward and lower to ground.



15.1.4. Roll bucket or attachment forward until it disconnects from attachment.

15.1.5. Reinstall handle pins to quick attach and secure using lynch pins.

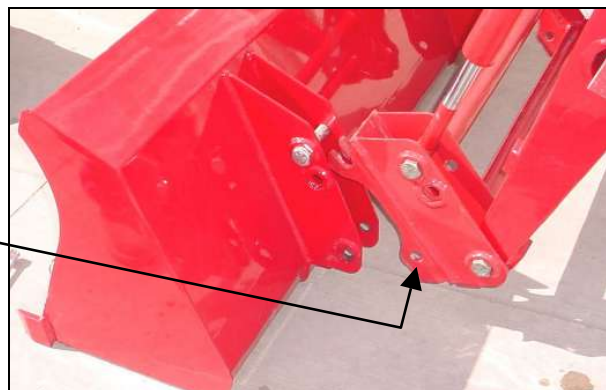

16. OPTIONAL SKID STEER TOOL CARRIER SYSTEM

IMPORTANT: Read safety information in this section and on decal before operating attachment.

 **WARNING**

Do not operate without confirmation that coupler pins are fully engaged. Loader attachment can fall off if not properly attached.

To avoid serious injury or death:

- Only use loader manufacturer approved attachments.
- Read all operators manuals and decals before operating. Follow all safety, operating, and service instructions. Contact dealer for replacement parts.

0595-3051

NOTE: Skid Steer Tool Carrier System is optional equipment



WARNING: Always read and follow operating instructions before operating Skid Steer Tool Carrier System.



16.1. RECOMMENDED LOADER FACTORY APPROVED ATTACHMENTS

16.1.1. Use only Loader Factory Approved Attachments for mounting on this Skid Steer Tool Carrier System.

16.2. NON-LOADER FACTORY ATTACHMENTS

16.2.1. If you are going to connect a non-Loader Factory Attachment to this Skid Steer Tool Carrier System, read and understand the following instructions and safety information. Always make sure Skid Steer Tool Carrier is locked onto all attachments.

NOTE "A": If your attachment back is not running at a 20 degree angle, your loader rollback and dump angles will change per attachment angle change.

NOTE "B": If your attachment point is lower than this, your attachment may not touch the ground when loader is fully lowered.

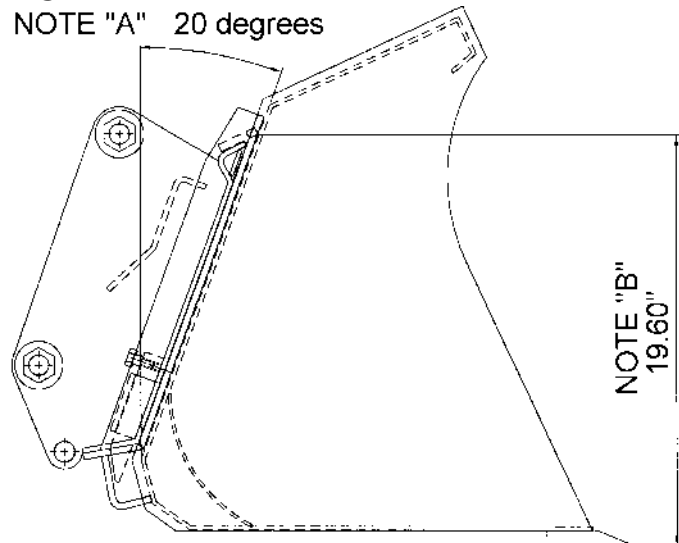

16.3. SKID STEER TOOL CARRIER SYSTEM SERVICE & LUBRICATION

IMPORTANT: To maintain your Skid Steer Tool Carrier System functioning properly, always keep handle components and latching areas clean.

Keep all these areas clean.

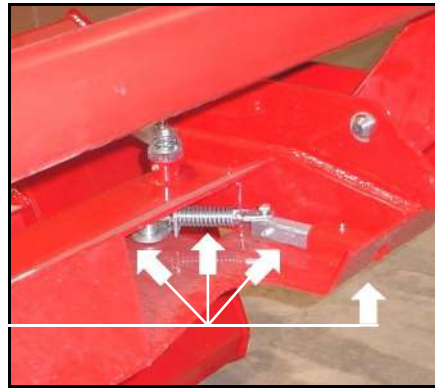

Keep these areas clean on your attachment.

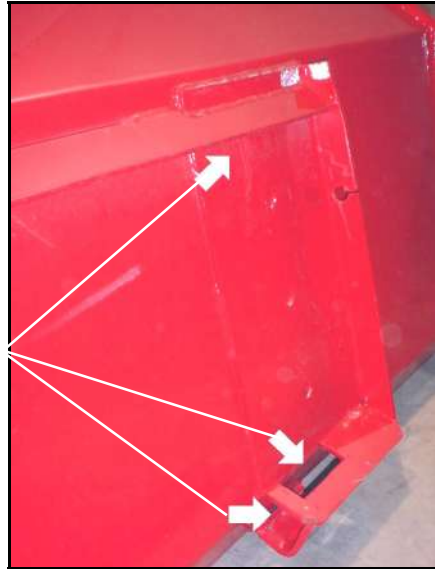

16.3.1. Inspect latching components and pins. If damaged, only replace with Factory approved components.

Check and tighten this 1/2" bolt after every 20 hours of operation, 1 place each side.

Lubricate these 2 grease fittings, 2 places each side, every 2 months of operation.

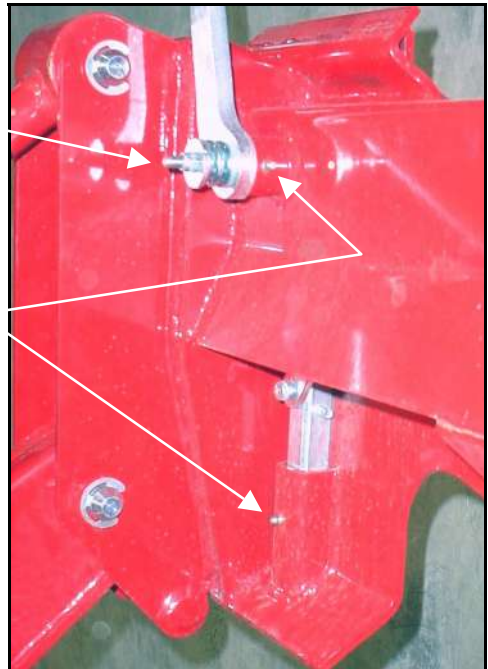

IMPORTANT: To maintain your Skid Steer Tool Carrier System functioning properly, always inspect Skid Steer Tool Carrier System components for damage or wear. If damage or wear exists, replace components immediately.

17. INSTALLATION & OPERATION OF SKID STEER TOOL CARRIER SYSTEM

IMPORTANT: Read safety information in this section and on decal before operating attachment.



WARNING

Do not operate without confirmation that coupler pins are fully engaged. Loader attachment can fall off if not properly attached. To avoid serious injury or death:

- Only use loader manufacturer approved attachments.
- Read all operators manuals and decals before operating. Follow all safety, operating, and service instructions. Contact dealer for replacement parts.

0595-3051



WARNING: Always read and follow operating instructions before operating Skid Steer Tool Carrier System.

17.1. INSTALLATION INSTRUCTIONS

IMPORTANT: Do not extend bucket cylinders without Skid Steer Tool Carrier installed on loader. Failure to follow these instructions could cause loader damage and void warranty.

17.1.1. Install Skid Steer Tool Carrier to loader and secure.

Top Pin 1" x 4.50" and E-Clip, LH side.
Top Pin 1" x 4.75" and E-Clip, RH side.

Center hole is not used on ML114.

Bottom Pin 1" x 4.50" and E-Clip, both sides.

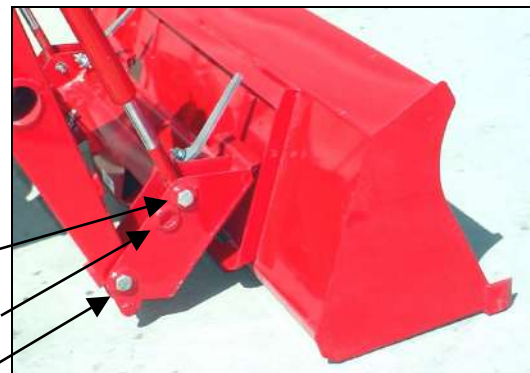

NOTE: Locate tilt cylinder grease zerk upward.

17.2. SKID STEER TOOL CARRIER HANDLES IN DISENGAGED POSITION

17.2.1. To position handles into the handle disengaged position, pull skid steer tool carrier handle upward.

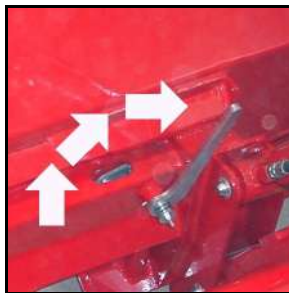

Pull Handles Upward

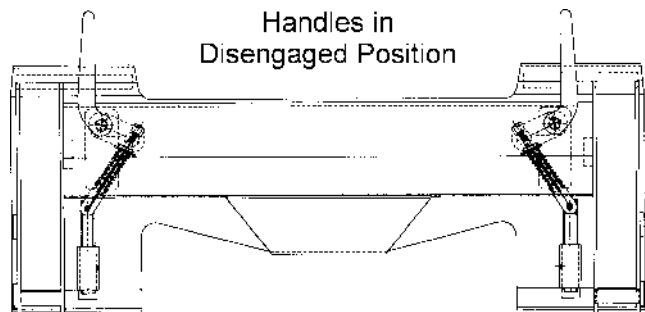

Handles in Disengaged Position

17.3. SKID STEER TOOL CARRIER HANDLES IN ENGAGED POSITION

17.3.1. To position handles into the handle engaged position, push skid steer tool carrier handle downward until they latch into position.



Push Handles Downward.

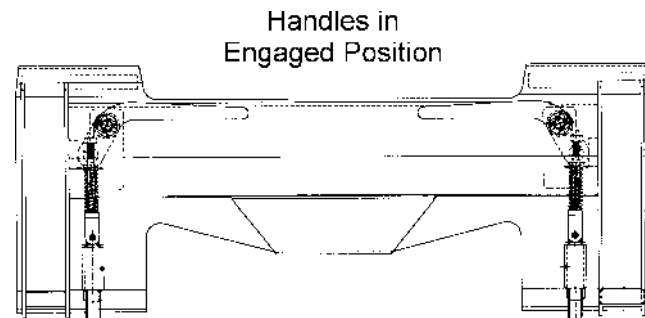

Handles in Engaged Position

18. INSTALLING BUCKET OR ATTACHMENT TO SKID STEER TOOL CARRIER

IMPORTANT: Refer to Page 53 for instructions concerning Skid Steer Tool Carrier Handles Disengaged and Engaged Positions.



CAUTION: Before leaving the tractor seat, stop the engine and lock brakes when installing or removing bucket or attachment.



CAUTION: Do not stand, walk, or work under a raised loader or attachment unless it is securely blocked or held in position. Accidental movement of valve handle/handles or leaks in the hydraulic system could cause the loader to drop, or attachment to dump, causing severe injury.

18.1. OPERATING INSTRUCTIONS

18.1.1. To attach bucket or attachment to loader, lower loader boom to ground with Skid Steer Tool Carrier attachment rolled forward slightly.



18.1.2. To position handles into the handle disengaged position, pull skid steer tool carrier handle upward.

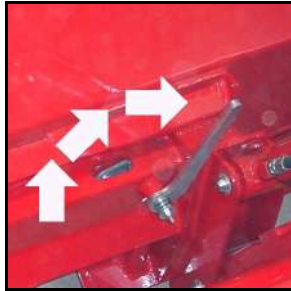

Pull Handles Upward

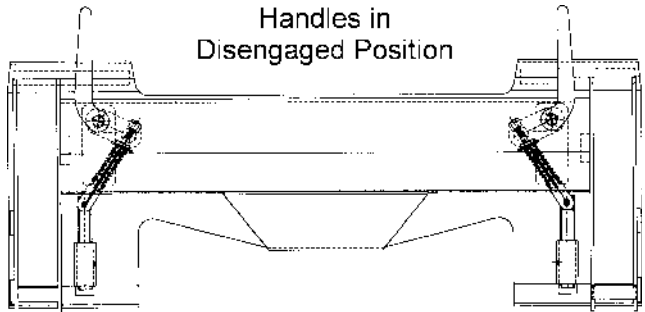

Handles in Disengaged Position

18.1.3. Roll Skid Steer Tool Carrier attachment forward by extending tilt cylinders just enough to allow Skid Steer Tool Carrier upper vee to engage Skid Steer attachment vee channel. Drive tractor forward, aligning Skid Steer Tool Carrier vee components.

Align Skid Steer Tool Carrier vee with Skid Steer Attachment vee channel.

NOTE: Over extension of tilt cylinders during this operation could cause damage to Skid Steer Tool Carrier handles due to handles contacting bucket or attachment.

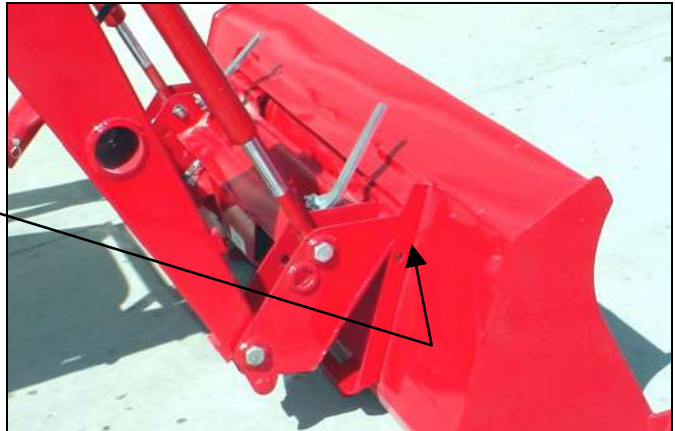

18.1.4. When Skid Steer Tool Carrier attachment is aligned with bucket or attachment, raise loader boom slowly making sure Skid Steer Tool Carrier vee components engage. Then roll Skid Steer bucket or attachment back slowly.

18.1.5. Position loader so attachment is approximately 1" off ground.

Positioned approx. 1" Off Ground

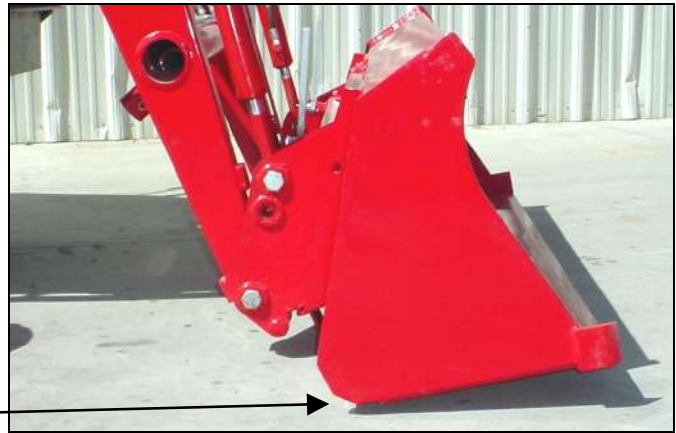

18.1.6. To position handles into the handle engaged position, push skid steer tool carrier handle downward until they latch into position.

NOTE: Handles should be positioned parallel to ground if properly latched.

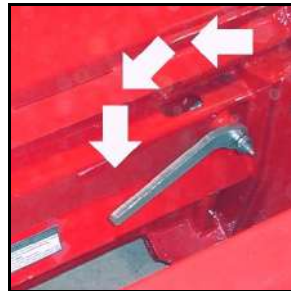

Push Handles Downward.

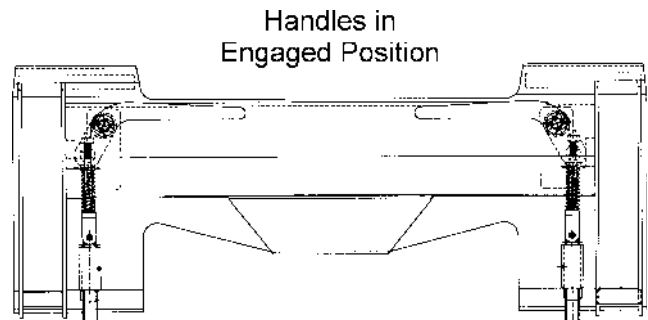

18.1.7. Check that bucket or attachment is securely attached to Skid Steer Tool Carrier by raising loader boom 3 to 4 feet, dumping bucket or attachment against stops, and checking to be sure bottom of bucket or attachment does not roll forward away from Skid Steer Tool Carrier Assembly.



18.1.8. Inspect Skid Steer Tool Carrier attaching areas to verify that Skid Steer Tool Carrier locking pins have engaged bucket or attachment fully.

NOTE: If locking pin is properly engaged, the clearance between the locking pin roll pin and the top edge of the locking pin guide should measure between 0" and 1/4".

Top Edge of Locking Pin Guide.
Skid Steer Tool Carrier Locking Pin, shown engaging bucket or attachment.

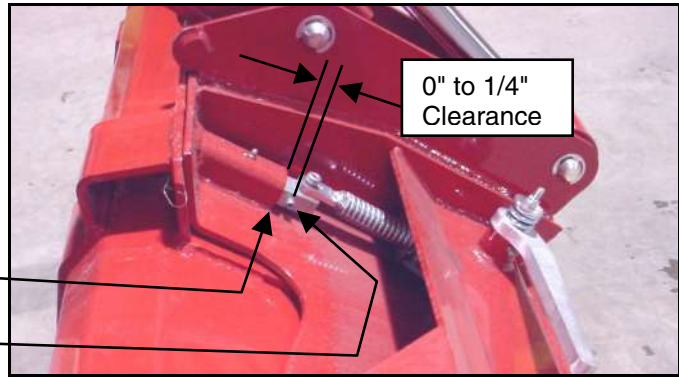

IMPORTANT: If properly latched into Skid Steer Tool Carrier attachment, the lower groove pin should be contacting pin support bar.

Bucket or Attachment contact point.
Skid Steer Tool Carrier Locking Pin, shown engaging bucket or attachment.

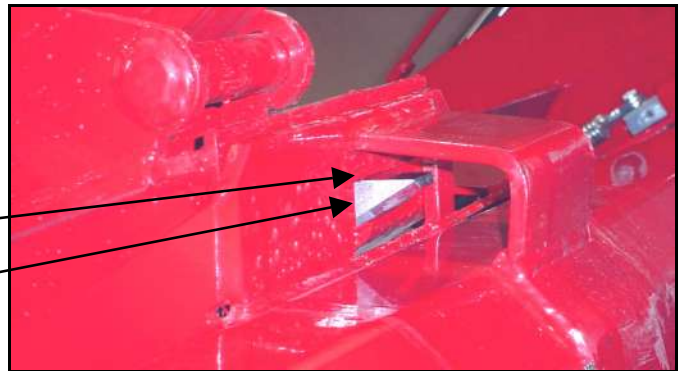

WARNING: A bucket or attachment that is not securely locked into Skid Steer Tool Carrier could come off during loader operation causing serious injury or death.

19. REMOVING BUCKET OR ATTACHMENT FROM SKID STEER TOOL CARRIER

IMPORTANT: Refer to Page 53 for instructions concerning Skid Steer Tool Carrier Handles Disengaged and Engaged Positions.



CAUTION: Before leaving the tractor seat, stop the engine and lock brakes when installing or removing bucket or attachment.



CAUTION: Do not stand, walk, or work under a raised loader or attachment unless it is securely blocked or held in position. Accidental movement of valve handle/handles or leaks in the hydraulic system could cause the loader to drop, or attachment to dump, causing severe injury.

19.1. OPERATING INSTRUCTIONS

19.1.1. To disconnect bucket or attachment from loader, position bucket or attachment slightly rolled back and approximately 1" off of ground.

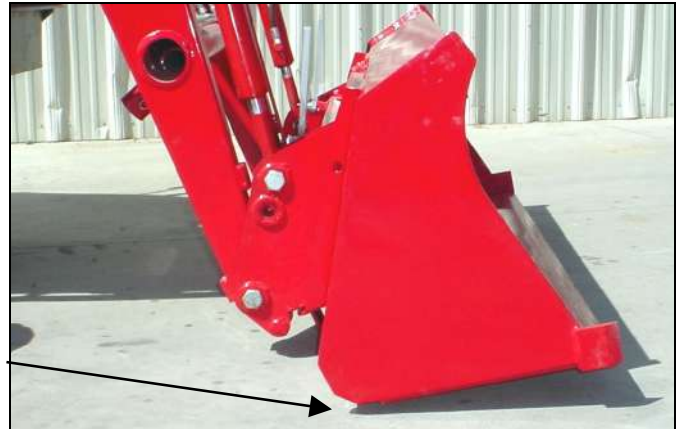

Positioned approx. 1" Off Ground

19.1.2. Position handles into the handle disengaged position by pulling skid steer tool carrier handle upward.



Pull Handles Upward

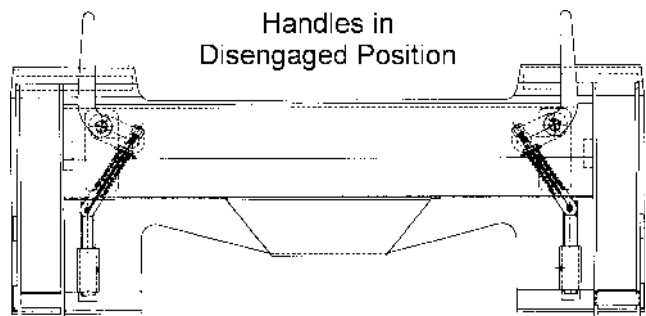

19.1.3. Roll bucket or attachment forward and lower to ground. Back loader away from bucket or attachment.

NOTE: Over extension of tilt cylinders during this operation could cause damage to Skid Steer Tool Carrier handle due to handle contacting bucket or attachment.



20. TROUBLE SHOOTING PROCEDURES

This Trouble Shooting Chart is provided for reference to possible loader operational problems.

Determine the problem that best describes the operational problem being experienced and eliminate the possible causes as listed by following the correction procedures.

For further assistance contact your dealer.

PROBLEM	POSSIBLE CAUSE	CORRECTION
Lift and Tilt Cylinders inoperative	Low hydraulic fluid level.	Check and replenish hydraulic fluid.
	Hydraulic hoses connected improperly.	Check and correct hydraulic hose connections
	Hydraulic Hoses to/from loader valve blocked.	Check for damaged (kinked) hoses, etc.
	Loader valve or tractor main relief valve stuck open.	Check system pressure. Repair or replace relief valve.
	Low system pressure supplied from hydraulic pump.	Check system pressure. Repair or replace pump.
	Loader valve linkage broken.	Inspect. Repair as required.
	Quick disconnect coupler(s) are not fully connected.	Check coupler connections. Replace coupler(s) if necessary.
	Hydraulic hose or tubeline blockage.	Check all hoses and tubes for leaks, damage, or restrictions. Replace damaged or restricted hoses or tube lines.
Lift and/or tilt cylinders operate in wrong direction relative to valve handle position	Cylinder piston assembly defective (not sealing).	Check cylinders for internal leakage as described in service section under cylinder leakage tests.
	Loader valve blockage.	Inspect for blockage. Disassemble valve if necessary.
Attachment will dump but will not rollback	Hydraulic hoses connected incorrectly.	Correct hydraulic hose connections.
Slow or erratic lift	Hydraulic circuit connected incorrectly.	Refer to plumbing diagram on Page 28 and correct hose connections.
	Low hydraulic fluid level.	Check and replenish hydraulic fluid.
	Cold hydraulic fluid.	Allow hydraulic system to warm up to operating temperature.
	Engine R.P.M. too slow (hydraulic pump R.P.M. too slow).	Increase engine speed to obtain satisfactory loader operation.
	Excessive weight in bucket. Material weight exceeds maximum specified loader capacity.	Reduce material load.
	Loader valve linkage binding/defective.	Check loader valve linkage and repair if worn/defective.
	Aeration of hydraulic fluid	Refer to "Aeration of Hydraulic Fluid".
Quick disconnect coupler restriction or coupler.	Check coupler connections. Repair or replace.	

PROBLEM**POSSIBLE CAUSE****CORRECTION****Inadequate lifting capacity**

Hydraulic hose or tubeline restriction (hoses/tubeline kinked or pinched).

Check hoses and tubelines for evidence of restriction.

Lift cylinder piston assembly leakage.

Check cylinders for leakage. Repair as needed.

Relief valve erratic or set below specifications.

Check and reset relief valve setting as needed.

Loader valve leaking internally. (Bypassing fluid within valve.)

Replace loader valve and recheck operation.

Inadequate hydraulic pump capacity.

Refer to "Hydraulic Pump Capacity Inadequate".

Engine R.P.M. too slow.

Increase engine R.P.M.

Excessive load – material weight exceeds specified loader capacity.

Reduce Load.

Relief valve setting below specifications.

Check and reset relief valve setting as needed.

Lift cylinder piston assembly leakage.

Check cylinders for leakage. Repair as needed.

Loader valve leaking internally.

Replace loader valve and recheck operation.

Hydraulic pump defective.

Refer to "Hydraulic Pump Capacity Inadequate".

Aeration of Hydraulic Fluid (generally indicated by foamy appearance of fluid).

Low hydraulic fluid level.

Check and refill hydraulic system to proper level.

Air leaking into suction side of hydraulic pump.

Check for loose or defective connections between reservoir and hydraulic pump.

Hydraulic fluid foaming due to improper hydraulic oil usage.

Refer to Tractor Operator's Manual and replace hydraulic oil using recommended hydraulic oil.

System relief valve squeals.

Cold Hydraulic Fluid.

Allow hydraulic fluid to warm up to operating temperature.

Excessive load in bucket. Weight exceeds specified loader capacity.

Reduce load.

Relief valve setting below specifications.

Check and reset valve setting as needed.

Hydraulic hose, tubeline, or quick disconnect coupler restriction.

Check for evidence of restriction in hydraulic oil flow. Repair or replace defective components.

PROBLEM	POSSIBLE CAUSE	CORRECTION
Loader drops with loader valve spool in "Centered" position (no external oil leakage evident.)	Cylinder Piston assembly leakage.	Check cylinders for leakage.
	Loader valve internal leakage. Note: A gradual drop over an extended period of time is a normal condition.	Replace loader valve and recheck.
Loader valve spool(s) will not return to centered position.	Valve handle linkage binding.	Determine origin of binding and repair.
	Loader valve spool centering is broken.	Replace centering spring.
	Loader valve spool binding in valve body spool bore.	Disassemble valve for inspection and repair.
Loader bucket moves freely after dumping load	Tilt cylinder cavitation has occurred.	Use of regen function while dumping load will eliminate problem. Refer to Page 29. Contact Factory for optional orifice kit availability.
External hydraulic fluid leakage.	Loose hydraulic connection.	Tighten loose connections.
	Defective hydraulic hose, tubeline, adapter fitting or adapter fitting o-ring.	Check for origin of oil leak and replace defective part.
	Loader valve o-rings defective.	Replace defective o-rings.
	Loader valve spool or body damaged or worn.	Replace loader valve.
	Cylinder rod packing set leakage.	Check cylinders for leakage. Repair as needed.
Hydraulic pump capacity inadequate.	Cold hydraulic fluid.	Allow hydraulic fluid to warm up to operating temperature.
	Engine R.P.M. too slow.	Increase engine R.P.M.
	Low hydraulic fluid supply.	Refer to Tractor Operator's Manual for service recommendations.
	Hydraulic hose restriction.	Check for evidence of restriction in hydraulic hoses.
	Hydraulic pump defective.	Refer to Tractor Operator's manual for recommended service procedures. Replace hydraulic pump if determined to be defective.
Lift cylinder rods bend when lift cylinders extended.	Excessive shock load on lift cylinders during transport.	Replace defective parts. Review and observe proper and safe operational practices.
Bucket cutting edge wear is uneven side to side	Bucket is not level to ground.	Check rear tire inflation and adjust to level bucket to ground.

PROBLEM

Bucket cutting edge wear rate is excessive. (Wear rate is even across full width of bucket).

POSSIBLE CAUSE

Incorrect operational practices.
Excessive down pressure placed on bucket when used on hard abrasive surfaces.

Bucket wear pads worn.

Note: Extensive use of bucket on concrete or asphalt surfaces will accelerate wear rate of bucket cutting edge.

CORRECTION

Refer to operation – scraping section for correct operating procedures. Utilize float position.

Replace wear pads.

Loader is slow and/or will not dump.

Hydraulic oil too heavy.

Change to proper oil.

Oil filter plugged.

Clean or replace filter.

Hydraulic pump worn.

Repair or replace pump.

Oil line restricted or leaking.

Check all hoses and tubes for leaks, damage or restrictions. Replace damaged or restricted hoses or tube lines.

Loader valve does not shift properly.

Inspect clean, repair, or replace valve.

Cylinder leaks internally.

Replace seals.

Faulty valve.

Repair or replace valve.

Loader chatters or vibrates when raising or lowering.

Air in hydraulic system.

Cycle lift cylinders and tilt cylinders.

Slow leakdown.

Oil level too low.

Add oil as required.

Worn loader valve.

Have authorized Mahindra dealer replace seals.

Worn cylinder piston seals.

Have authorized Mahindra dealer replace seals.

Attachment will dump but will not rollback





Hydraulic circuit connected incorrectly.

Check that Port "C" of loader valve is connected to tilt cylinder base end and that Port "D" of loader valve is connected to rod end of tilt cylinder.

21. TORQUE CHART

SAE FASTENER TORQUE CHART



NOTE: Use these torques, unless special torques are specified. Values are for UNC and UNF thread fasteners, plated or unplated, as received from supplier. Fasteners can be dry or lubricated with normal engine oil. Values do not apply if graphite, moly-disulphide or other extreme pressure lubricant is used.

SAE Grade No.	2				5				8*				
Bolt head identification (See Note 1)													
Bolt Size	LB FT		Nm		LB FT		Nm		LB FT		Nm		
	Min.	Max.	Min.	Max.	Min.	Max.	Min.	Max.	Min.	Max.	Min.	Max.	
1/4	5	6	7	8	9	11	12	15	12	15	16	20	
5/16	10	12	14	16	17	20.5	23	28	24	29	33	39	
3/8	20	23	27	31	35	42	48	57	45	54	61	73	
7/16	30	35	41	47	54	64	73	87	70	84	95	114	
1/2	45	52	61	70	80	96	109	130	110	132	149	179	
9/16	65	75	88	102	110	132	149	179	160	192	217	260	
5/8	95	105	129	142	150	180	203	244	220	264	298	358	
3/4	150	185	203	251	270	324	366	439	380	456	515	618	
7/8	160	200	217	271	400	480	542	651	600	720	814	976	
1	250	300	339	406	580	696	787	944	900	1080	1220	1464	
1-1/8					800	880	1085	1193	1280	1440	1736	1953	
1-1/4					1120	1240	1519	1681	1820	2000	2468	2712	
1-3/8					1460	1680	1980	2278	2380	2720	3227	3688	
1-1/2					1940	2200	2631	2983	3160	3560	4285	4827	

NOTE 1: Bolt head identification marks as per grade. Manufacturing marks will vary. *Thick nuts must be used with Grade 8 bolts

METRIC FASTENER (ISO) TORQUE CHART

NOTE: Use these torques, unless special torques are specified. Values are for course thread fasteners, plated or unplated, as received from supplier. Fasteners can be dry or lubricated with normal engine oil. Values do not apply if graphite, moly-disulphide or other extreme pressure lubricant is used.

ISO Class No.	8.8				10.9				12.9			
Bolt head identification (See Note 1)												
Bolt Size	Nm		LB FT		Nm		LB FT		Nm		LB FT	
	Min.	Max.	Min.	Max.	Min.	Max.	Min.	Max.	Min.	Max.	Min.	Max.
M4	3	4	2	3	4	5	3	4				
M5	6.5	8	5	6	9.5	11	7	8				
M6	10.5	12	8	9	15	17.5	11	13				
M8	26	31	19	23	37	43	27	32				
M10	52	61	38	45	73	87	54	64				
M12	90	107	66	79	125	150	93	112				
*M14	144	172	106	127	200	245	149	179				
M16	217	271	160	200	310	380	230	280				
M20	434	515	320	380	610	730	450	540				
M24	675	815	500	600	1050	1275	780	940				
M30	1250	1500	920	1100	2000	2400	1470	1770				
M36	2175	2600	1600	1950	3500	4200	2580	3090				

Because of the low ductility of these fasteners, the torque range is to be determined individually for each application. As a general rule, the torque ranges specified for grade 10.9 fasteners can be used satisfactorily on 12.9 fasteners.

*M14 is not a preferred size

NOTE 1: Bolt head identification marks as per grade. Manufacturing marks will vary

Supplemental Cylinder Service Instructions for ML114

Use the following instructions along with your Loader Operator's Manual.

Applies to:

Lift cylinders - ML114 Loader Serial Number 044519165 and after.

Tilt cylinders - ML114 Loader Serial Number 044519165 and after.

1. If your loader is equipped with cylinder part number 3160-2039 for lift cylinders and part number 3150-2058 for tilt cylinders, refer to your Loader Operator's Manual for exploded Parts Drawing, Parts List and cylinder hose requirements. Part numbers are stamped on cylinder barrel at rod end. Also see picture Figure 1 below for help in identifying your cylinder design.
2. If your loader is equipped with cylinder part number 3160-2059 for lift cylinders and part number 3150-2083 for tilt cylinders, refer to the following for exploded Cylinder Parts Drawing, Parts List and cylinder hose requirements. Part numbers are stamped on cylinder barrel at base end. Also see picture Figure 2 below for help in identifying your cylinder design.



Figure 1

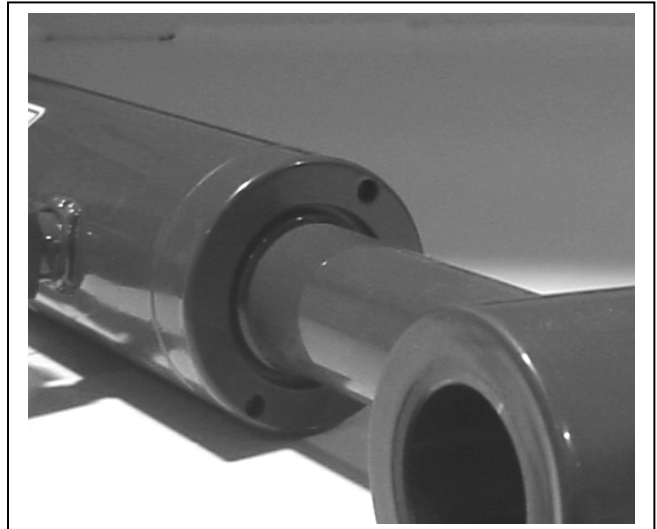
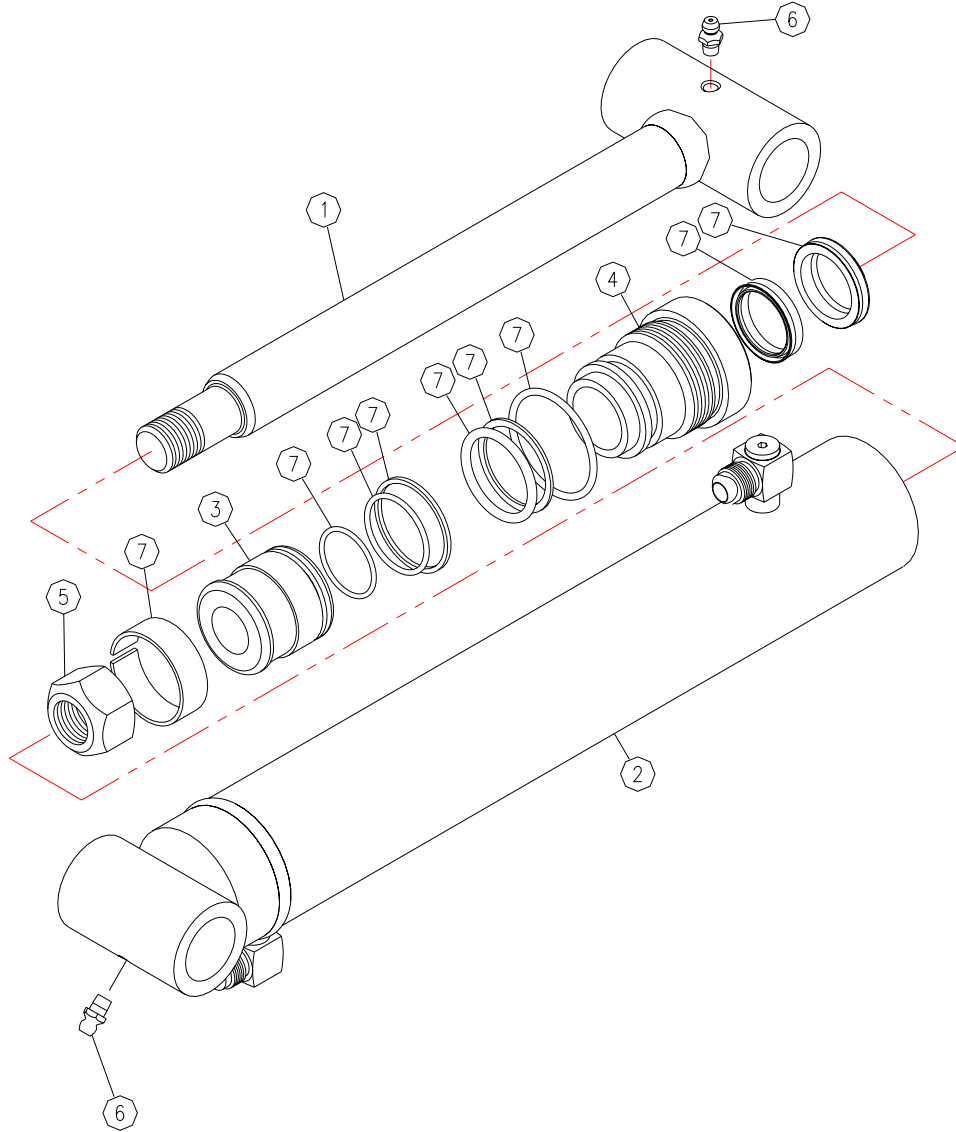

Figure 2

LIFT CYLINDER



<u>Reference</u>	<u>Description</u>	<u>Part No.</u>	<u>Qty.</u>
1	Rod Assembly	0200-2072	1
2	Tube Assembly	0100-2076	1
3	Piston	0405-2015	1
4	Gland	0330-2024	1
5	Locknut	0530-2007	1
6	Zerk	0530-2008	2
7	Seal Kit	0590-2034	1

TILT CYLINDER

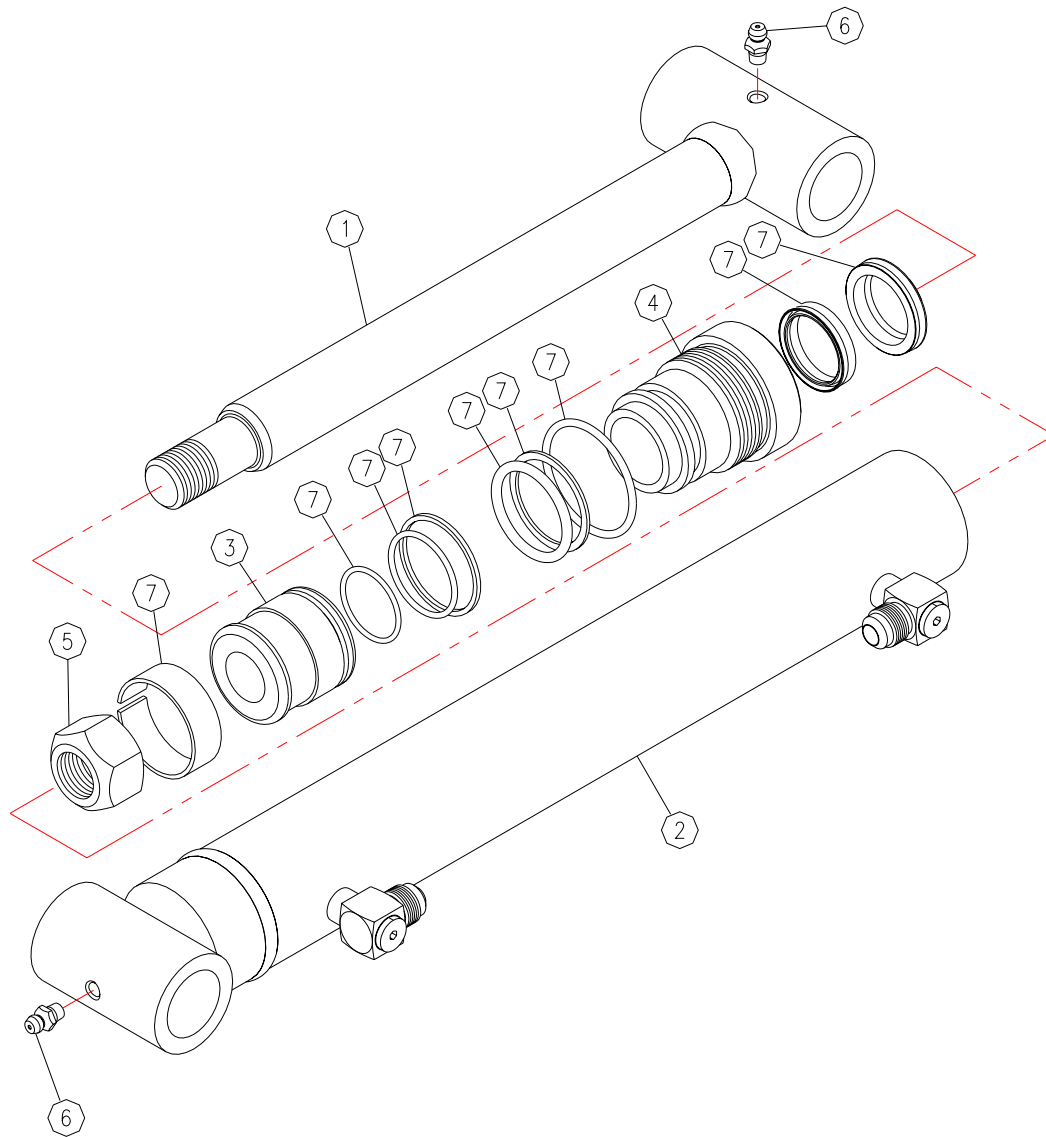

Reference	Description	Part No.	Qty.
1	Rod Assembly	0200-2073	1
2	Tube Assembly	0100-2077	1
3	Piston	0405-2015	1
4	Gland	0330-2024	1
5	Locknut	0530-2007	1
6	Zerk	0530-2008	2
7	Seal Kit	0590-2033	1

HYDRAULIC CYLINDERS and HOSES

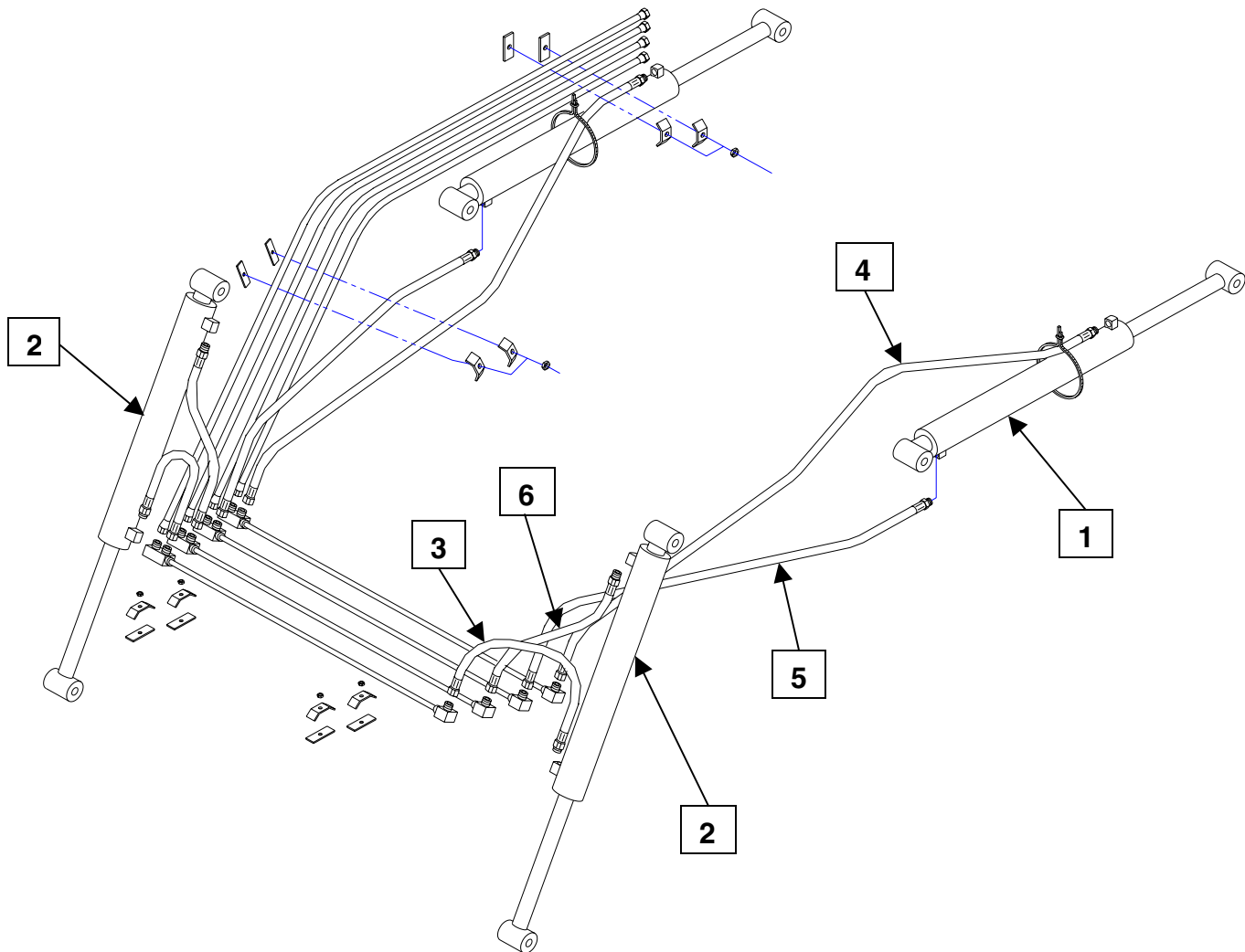

Reference	Description	Part No.	Qty.
1.....	Hydraulic Cylinder, Lift	3160-2059	2
2.....	Hydraulic Cylinder, Tilt	3150-2083	2
3.....	Hydraulic Hose Assembly, 3/8" x 18"	22506506018 ...	2
4.....	Hydraulic Hose Assembly, 3/8" x 56"	22506506056 ...	2
5.....	Hydraulic Hose Assembly, 3/8" x 32"	22506506032 ...	2
6.....	Hydraulic Hose Assembly, 3/8" x 22"	22506506022 ...	2